

Operating manual

ZENTRIMIX 380 R

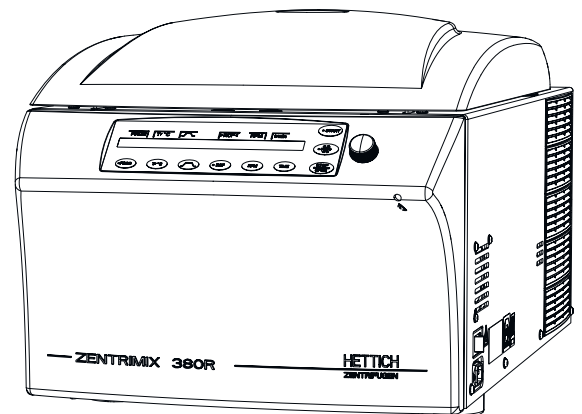
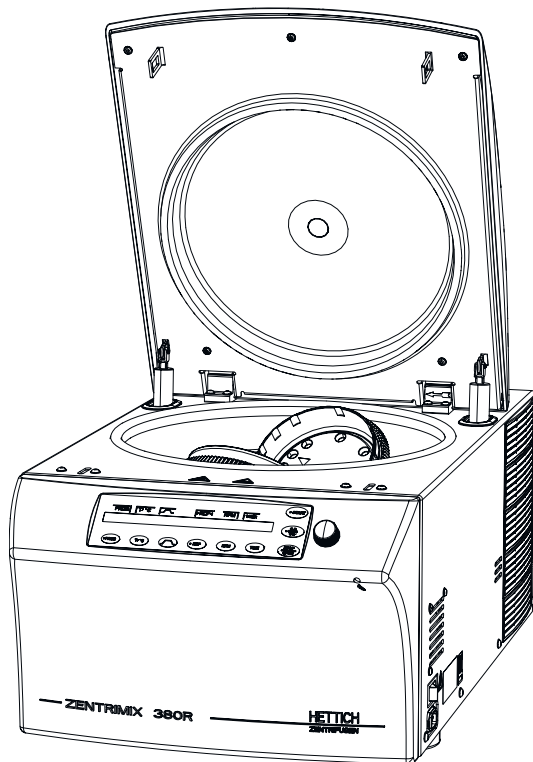

Translation of the original operating manual

© 2017

Rev. 06 / 04.2025

Andreas Hettich GmbH

Föhrenstraße 12

78532 Tuttlingen

Deutschland

Telephone: +49 (0)7461 / 705-0

Fax: +49 (0)7461 / 705-1125

Email: info@hettichlab.com

Email: service@hettichlab.com

Internet: www.hettichlab.com

Table of contents

1	Introduction.	5
1.1	Symbols.	5
1.2	Important labels on the packaging.	8
1.3	Personal protective equipment.	9
1.4	Personnel qualification.	9
1.5	Intended use.	9
1.6	Replacement parts/consumable material.	10
1.7	Scope of delivery.	10
1.8	Return shipments.	11
1.9	European registration.	11
2	Safety information.	11
3	Device description.	16
4	Transport and storage.	18
5	Commissioning.	19
5.1	Unpacking the device.	20
5.2	Setting up, connecting and switching on the device.	21
6	Operation.	24
6.1	Operating elements.	24
6.2	Opening the lid.	27
6.3	Closing the lid.	27
6.4	Quick-stop function.	28
6.5	Removing and installing the rotor.	28
6.6	Loading the rotor.	31
6.6.1	Loading a rotor for classical centrifugation.	31
6.6.2	Loading a rotor for dual centrifugation.	31
6.6.3	Handling of bio-safety systems.	34
6.6.3.1	Opening and closing the lid of bio-safety systems.	34
6.6.3.2	Storage of bio-safety systems.	35
6.7	Starting centrifugation.	35
6.8	Dual centrifugation: Validating application.	36
6.9	Emergency unlocking.	38
6.10	Cooling.	39
7	Software description.	39
7.1	Program settings.	40
7.1.1	Calling up/loading program (RCL 1-99).	41
7.1.2	Save programs (STO 1-99).	41
7.1.3	Calling up/loading a program link (RCL A-Z).	42
7.1.4	Editing a program link (EDIT A-Z).	43
7.1.5	Saving a program link (STO A-Z).	43

7.2	Centrifugation parameters.	44
7.2.1	Temperature (t/°C).	45
7.2.2	Start-up and run-down parameters.	45
7.2.2.1	Start-up stage and start-up time.	45
7.2.2.2	Braking stage and run-down time.	46
7.2.2.3	N Brake.	46
7.2.3	RCF and RAD.	47
7.2.4	Speed (RPM).	48
7.2.5	Runtime (t/hms).	49
7.2.6	Precooling of the rotor.	51
7.3	Machine Menu.	51
7.3.1	Change Lock.	52
7.3.2	Change PIN.	52
7.3.3	Info.	54
7.3.4	Operating Time.	55
7.3.5	Settings.	58
7.3.5.1	Sound/Bell.	58
7.3.5.2	Sound/Bell error.	58
7.3.5.3	Start program.	59
7.3.5.4	Temp Unit.	59
7.3.5.5	Ramp Unit.	60
7.3.5.6	RCF Integral.	60
7.3.5.7	B-Ramp.	60
7.3.5.8	Multi programs.	61
7.3.5.9	PC Address.	61
7.3.5.10	Cool acc time.	61
7.3.5.11	Cool dec speed.	62
7.3.5.12	Dual time mode.	62
8	Cleaning, disinfection and maintenance.	63
8.1	Cleaning.	63
8.2	Disinfection.	64
8.3	Maintenance.	65
9	Troubleshooting.	66
9.1	Performing a mains reset.	69
10	Technical data.	69
10.1	Type plate.	71
10.2	Dimensions.	72
11	Disposal.	73
12	Glossary.	74
13	Index.	75
14	Appendix.	77
A	Rotors and accessories.	79

1 Introduction

1.1 Symbols

Signal words

Signal word	Meaning
DANGER	This combination of symbol and signal word indicates an immediate dangerous situation that will result in death or serious injury if it is not avoided.
WARNING	This combination of symbol and signal word indicates a possible dangerous situation that can result in death or serious injury if it is not avoided.
CAUTION	This combination of symbol and signal word indicates a possible dangerous situation that can result in minor injury if it is not avoided.
NOTICE	This combination of symbol and signal word indicates a possible dangerous situation that can result in material and environmental damage if it is not avoided.

Warning categories

Warning signs	Type of danger
	Warning – danger zone.
	Warning – hand injuries.
	Warning – high-voltage.

General symbols

→ This listing symbol denotes descriptions of tasks that you must perform.

■ This dot is for denoting lists.

Cross references are indicated as follows: ➔ *Chapter 1.1 ‘Symbols’ on page 5*

Symbols on the device



Warnings/symbols on the device which are no longer recognizable should be immediately replaced by the operating company.

The images shown in the following depict the positions of the warnings and symbols affixed to the device.

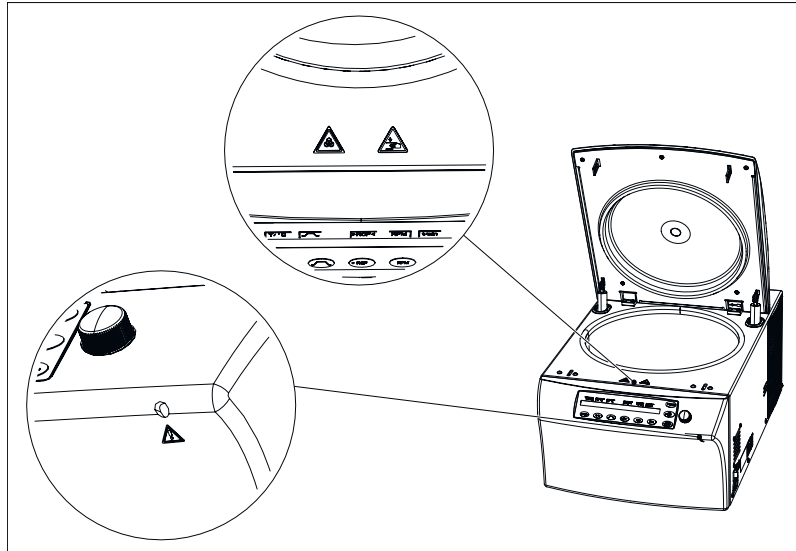

Fig. 1: Warnings on the device



Attention, general danger point

Non-observance of this warning can lead to material damage and personal injury.

Before using the device, make sure you read the operating instructions and observe the safety information.



Warning - Biological contamination!

Before using the device, make sure you read the operating instructions and observe the safety information.



Warning - Hand injury

Non-observance of this warning can lead to material damage and personal injury.

Before using the device, make sure you read the operating instructions and observe the safety information.

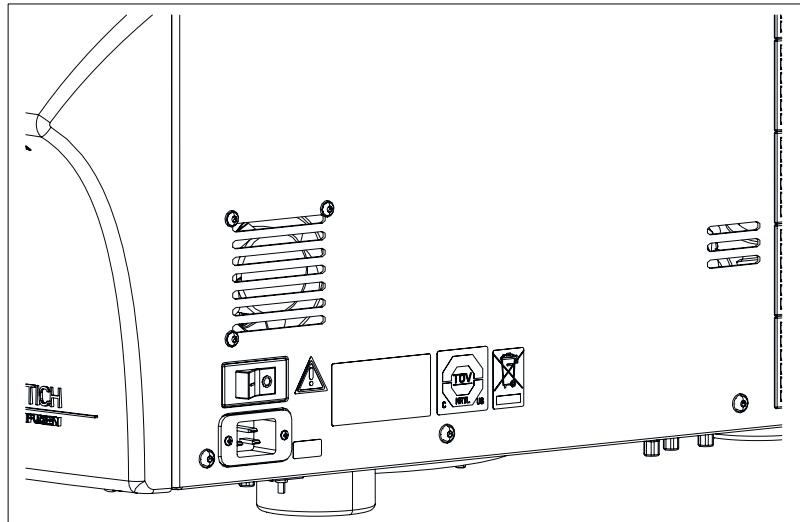

Fig. 2: Warning stickers on the right outer side



Attention, general danger point

Non-observance of this warning can lead to material damage and personal injury.

Before using the device, make sure you read the operating instructions and observe the safety information.

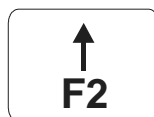

Warning on the circuit breaker (only for types with mains voltage of 110-127V)

This symbol denotes the circuit breaker (only for device with a circuit breaker).



Symbol for separate collection of electric and electronic devices

Symbol according to directive 2002/96/EC (WEEE). Applies in the countries of the European Union, as well as in Norway and Switzerland.

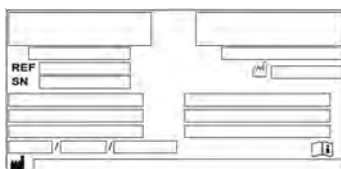

Type plate

Nameplate with technical data specifications.



Symbol for TÜV-inspected device

From TÜV-inspected device.

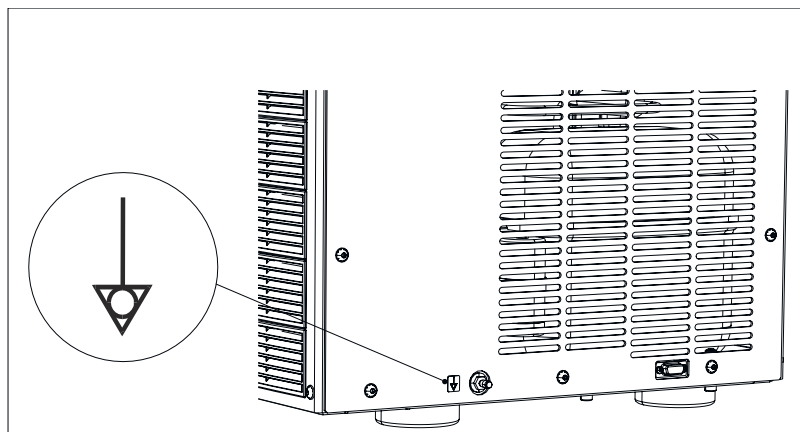

Fig. 3: Notice at equipotential connection



Symbol indicating connection of equipotential (only for types with mains voltage of 110-127V)

This symbol indicates the equipotential connection.

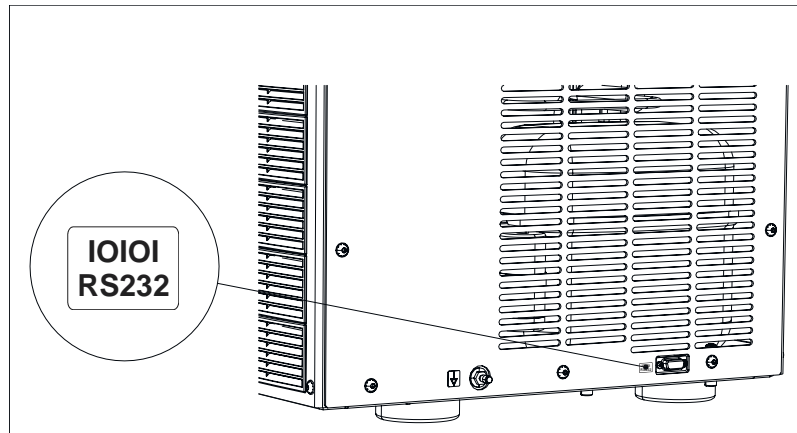

Fig. 4: Notice at the RS232 interface



Symbol for RS232 interface

This symbol indicates the RS232 interface (only for device with RS232 interface).

1.2 Important labels on the packaging

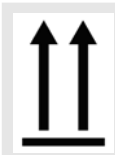

This way up.

Shows the correct upright position of the package.



Fragile, handle with care.

Refers to a medical device that can break or be damaged if handled carelessly.



keep dry

The shipping packaging must be kept away from rain and kept in a dry environment.

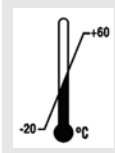

temperature range

The shipping packaging must be stored, transported and handled within the temperature range shown (-20°C - +60°C).

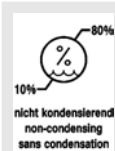

humidity range

The shipping packaging must be transported and handled within the indicated humidity range (10% - 80%).



Stack limit.

Maximum number of identical packages which may be stacked on the bottommost package, whereby "n" stands for the number of permissible packages. The bottommost package is not included in "n".

1.3 Personal protective equipment

The assessment of the personal protective equipment must take place on site according to the actual risks which are posed by the used substances, the procedures and the environmental conditions.

The operating company must create a risk assessment according to the corresponding standards and directives and enact work instructions which ensure the safe handling of the device and accessories.

1.4 Personnel qualification

Repairs may only be performed by a person authorized by the manufacturer.



Interventions and modifications to devices by persons not authorized by the company Andreas Hettich GmbH will be at one's own risk and result in the voiding of all warranty claims, as well as the voiding of liability claims against Andreas Hettich GmbH.

Authorized skilled personnel with special instruction

Skilled personnel are able to perform the work assigned to them and independently recognize and avoid potential hazards based on their specialized education (professionally recognized vocational training), knowledge and experience as well as knowledge of the relevant regulations.

Personnel have participated in special instruction by the manufacturer of the device or personnel authorized by the manufacturer and, through this, are authorized to perform the corresponding task.

Personnel have completely read and understood this documentation.

Service technician

A service technician is someone who, based on his professional training and advanced practical knowledge, provides expert support (installation, commissioning, maintenance, etc.) for our customers in all things mechanical, on the phone as well as on site, and is an employee of the company of the manufacturer or was trained and authorized by the manufacturer to carry out service work on the device.

1.5 Intended use

Intended use

Dual centrifugation: The purpose of the ZentriMix is to process samples pre-analytically in non-medical laboratories.

This includes the extraction, grinding, mixing and dissolving as well as homogenizing of samples, so also the decomposition of organic or inorganic materials.

Another purpose is the creation of nanoparticles through homogenization (e.g. lipid nanoparticles, particularly liposomes) for non-clinical uses.

Classical centrifugation: In its function as a classical centrifuge, it is used for the separation of materials or material mixtures with a density of max. 1.2 kg/dm³ in non-medical laboratories.

The device was not designed for use in environmental conditions that do not meet the manufacturer requirements or in a potentially explosive, radioactive or biologically or chemically contaminated atmosphere.

Improper use

The ZentriMix is only meant for the above-named purposes. Another use or one which goes beyond this is considered to be improper. The manufacturer is not liable for damage resulting from this.

Intended use also includes the observation of all information in the operating instructions and complying with the inspection and maintenance intervals.

The device was not designed for use under environmental conditions that do not meet the manufacturer requirements or in a potentially explosive, radioactive or biologically or chemically contaminated atmosphere.

The device is not meant for processing toxic, corrosive or infectious samples; such samples must not be processed in the ZentriMix.

Foreseeable misuse

The device is built according to the state-of-the-art and the recognized safety regulations. If used and handled improperly, there could be life-threatening danger to the user or third parties, or the device could be impaired or there could be other property damage. The device is only to be used for its intended purpose and only when it is in safe working condition. Malfunctions which could affect safety must be corrected immediately.

If consumable material approved/sold by the manufacturer is not used, there is a danger of container damage at high speeds, which could result in a spontaneously high unbalance and damage to the device.

Do not operate the device unsupervised.

If used improperly, incorrect input of the parameters can result in dangerous operating conditions: For example, if the duration of a run is entered too high, the sample could overheat, which could cause the sample container to burst, which could result in extreme unbalance at high speed and damage to the device.

1.6 Replacement parts/consumable material

Only original replacement parts and approved original accessories of the manufacturer may be used and only original consumable material or that recommended (approved) by the manufacturer in its official documentation may be used.



WARNING

If original replacement parts, consumable material approved or sold by the manufacturer and original accessories are not used, any warranty or liability claims against the company Andreas Hettich GmbH are void.

1.7 Scope of delivery

- 1x device
- 1 x mains cable (power supply)
- 1 x size 5 Allen wrench (for emergency release and mounting/dismounting the rotor)
- 1 x lubricating grease for lifting lugs
- 1x Allen wrench, size 2.5

- 1 x Allen keys, short, size T20 SG
- 1 x operating instructions



Rotor(s) and the corresponding accessories are included in delivery, depending on the order.

1.8 Return shipments

If the device or its accessories are sent to the manufacturer, this/these must be decontaminated and cleaned before shipping in order to protect personnel, the environment and material. For returns, please contact Hettich or the responsible Hettich sales partner. You will then receive a clearance certificate and return material authorization number. **Devices without a signed clearance certificate will not be accepted in order to protect our employees.** We ask for your understanding.

1.9 European registration

Device conformity

Device conformity according to EU directives.



Single Registration Number

SRN: DE-MF-000010680

2 Safety information



The device and its associated components and assemblies meet the currently valid safety standards individually and as a whole and meet the CE directives of the European Union.

The device is safe if used as intended and observing the descriptions and information given in this documentation.

Danger due to electrical energy



! WARNING

Warning of incorrect voltage on the device protection switch!

Pay attention to the correct operating voltage in order to prevent damage to the device.

- Only operate the device at the correct operating voltage.
- Refer to the technical data and nameplate for the value for the correct operating voltage.
- If the operating voltage is too high, the overcurrent protection fuse in the device switch can trip and the device electronics can be destroyed.

Danger due to kinetic energy



DANGER

Danger due to rotor moving with high kinetic energy!

There is a risk of injury if the lid is opened via the emergency release during device operation.

- Only open the device via the emergency release when the device is switched off.
- Before the emergency release, make sure that the device rotor has stopped.

Danger due to insufficient maintenance or maintenance not performed in a timely manner



DANGER

Danger due to insufficient maintenance or maintenance not performed in a timely manner!

There is a risk of collision inside the device due to insufficient maintenance or maintenance not performed in a timely manner.

- Have maintenance done at the specified intervals.
- Check the rotor for a firm fit before using the device. Correctly tighten the fastening screw. If the rotor has play, it must be replaced.
- Check the device for visible damage or deficiencies before use. If you discover deficiencies or damage, put the device out of operation and immediately inform an authorized service technician.

Warning of premature program abort



WARNING

Warning of premature program abort!

In the event of a premature program abort, such as a power failure, switching off during the program run or pulling out the mains plug, the desired effect on the samples might not be achieved.

- Do not switch off the device during a program run.
- Do not actuate the emergency release during a program run.
- Do not pull out the mains plug during a program run.
- After a program abort, check whether the samples can be used.

Warning of hand injury due to rotor gears



CAUTION

Warning of hand injury due to rotor gears!

There is a risk of injury to fingers by the rotor gears if this is turning. Cuts with possible infections could result.

- Do not grab between the gears of the rotating units and the rotor.
- Avoid rotor rotation with the lid open as much as possible.
- To prevent injuries to third parties, do not leave the device unsupervised with the lid open.

Risk of injury due to the device falling out of the packaging



WARNING

Risk of injury due to parts falling out of the packaging!

When parts fall out of the transport packaging, there is a risk of crushing injuries to extremities.

- Observe the warnings for opening the packaging.
- Only open the packaging at the specified point.

Warning of hand injury due to device lid falling closed unbraked



WARNING

Warning of hand injury due to device lid falling closed unbraked!

If the lid falls closed unbraked, there is a risk of extremities getting caught.

- Have the device maintained by a service technician at the specified intervals.
- Always open the device lid completely.
- If a gas pressure spring of the lid is defective, have it replaced by a service technician.

Danger posed by selection of unsuitable parameters for dual centrifugation



WARNING

Danger posed by selection of unsuitable parameters for dual centrifugation!

The maximum permissible speed (RPM) for ZentriMix applications depends on the sample composition and sample container. Every ZentriMix sample container can only be used up to a certain rotational speed depending on the design and application; this must not be exceeded under any circumstances! Otherwise, there is a danger that the sample container will not withstand the stress, and the device will be damaged due to the resulting unbalance; the heat that arises cannot be compensated by the cooling system, resulting in the sample container becoming very hot. Only remove such a container after a sufficient cooling-off time while wearing appropriate protective clothing.

- ZentriMix applications are to be carried out according to the protocol authorized by the manufacturer.
- Every application not yet described by a manufacturer protocol must be checked and validated for any hazard potential before its use. → *Further information on page 36.*
- The correct parameter input must always be checked.
- Do not leave the device unsupervised.

Damage due to incorrect loading for dual centrifugation**WARNING****Damage due to incorrect loading for dual centrifugation!**

The two rotor receptacles must be loaded strictly symmetrically with the same weight.

- Observe the loading rules. → *Chapter 6.6.2 'Loading a rotor for dual centrifugation' on page 31!*
- Observe the device as it starts up. If unusually high unbalance occurs, stop the run immediately by pressing the *[Stop/Open]* key twice and check the load. If you cannot determine that the load is incorrect, put the device out of operation and inform the Service department.

Danger due to hazardous substances in the sample**DANGER****Danger due to hazardous substances in the sample**

No materials or material mixtures may be processed in a way which poses a risk of fire or explosion.

- Therefore, thoroughly check the intended process regarding this hazard and take the appropriate measures to avoid personal injury.
- Follow the relevant regulations and directives for handling chemicals and hazardous substances.
- In particular, no aggressive chemicals may be used (e.g. dangerous, corrosive extracting agents, such as chloroform, strong acids).

Explosion and fire hazard**WARNING****Explosion and fire hazard**

Do not process any explosive materials or materials which can react together chemically with high energy. Substances which could create a hazardous explosive or flammable atmosphere in the device may not be processed. The estimation of such risks is the responsibility of the operating company. The operating company must instruct the user with regard to this.

- Therefore, thoroughly check the intended process regarding these hazards and take the appropriate measures to prevent personal injury.
- Follow the relevant regulations and directives for handling chemicals and hazardous substances.
- In particular, no aggressive chemicals may be used (e.g. dangerous, corrosive extracting agents, such as chloroform, strong acids).

Danger due to the penetration of water or other liquids**DANGER****Danger due to the penetration of water or other liquids!**

When water penetrates into the device, there is a danger of a short circuit and the user suffering an electric shock.

- Prevent water and moisture from penetrating into the device.
- Do not pour liquids into the device interior.
- The device must not stand in the rain.
- Transport is only allowed with suitable transport protection.

Warning - Impermissible ambient temperature**WARNING****Warning - Impermissible ambient temperature!**

If the ambient temperature is outside of the permissible ambient temperature range for the samples, these might be compromised.

- Observe the permissible maximum and minimum ambient temperatures for setting up the device.
- Do not place the device next to heat sources or devices which radiate heat.
- Check the samples after any device overheating to see if they can still be used and take new samples, if necessary.
- Make sure the device is not exposed to direct sunlight.
- Make sure the device is not exposed to frost.
- Maintain the minimum clearance around the device.
- Make sure that the fan is not blocked.
- Never operate the device in a continuous run.

Warning - Position changed due to vibration**WARNING****Warning - Position changed due to vibration!**

The device might fall down if the set-up surface vibrates or if it is not flat or stable enough.

- Only place the device on a stable, flat surface.
- The set-up surface must reliably bear the weight of the device.

Mechanical emergency release



! WARNING

There is a risk of injury if the mechanical emergency release of the device is actuated during the program run.

If the mechanical emergency release of the lid is actuated during a program run, the program is aborted and the rotor runs down unbraked.

- Only actuate the emergency release when the rotor is stopped.
- Check whether the rotor has stopped before an emergency release.

Danger of infections due to improper disposal



DANGER

Danger of infections due to improper disposal!

In the event of improper disposal of samples, there is a risk of injury to the user, disposal personnel and the environment.

- Observe the legal regulations for disposing of contaminated material.

3 Device description

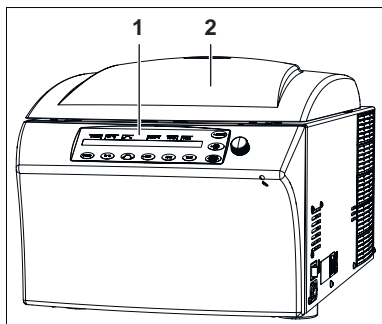

Fig. 5: Operating elements, front side

- 1 Operating panel
- 2 Lid

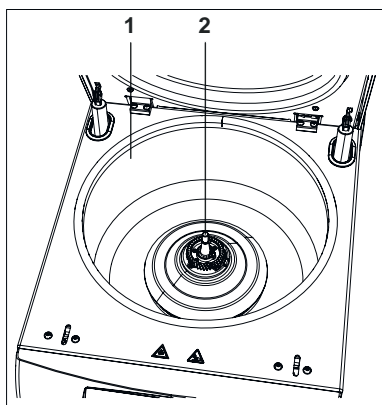

Fig. 6: Device interior

- 1 Centrifuging chamber
- 2 Rotor cavity



Further information about the control panel can be found in the Operation chapter → Chapter 6 'Operation' on page 24.

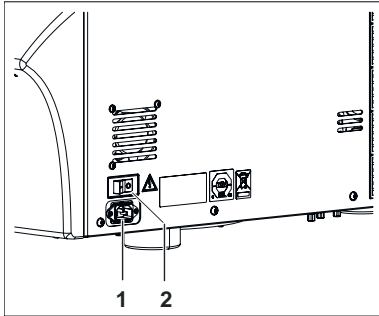

Fig. 7: Right outer side

- 1 Device plug (power supply)
- 2 Device switch [On/Off]

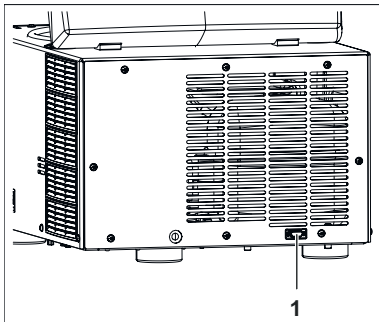

Fig. 8: Rear side

- 1 RS232 interface

Circuit breaker (only for types with mains voltage of 110-127V)

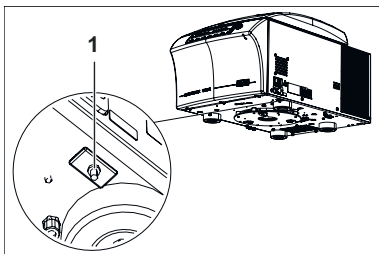

Fig. 9: Automatic circuit breaker

- 1 Automatic circuit breaker

On the bottom side of the device there is a circuit breaker for the transformer.

After the circuit breaker trips, proceed as follows:

1. ➤ Switch the device off and pull out the device plug (disconnect from the mains)!
2. ➤ Press the plastic pin of the circuit breaker upward.
3. ➤ Connect the device to the mains again and switch it on.

4 Transport and storage

Dimensions and weight with transport packaging

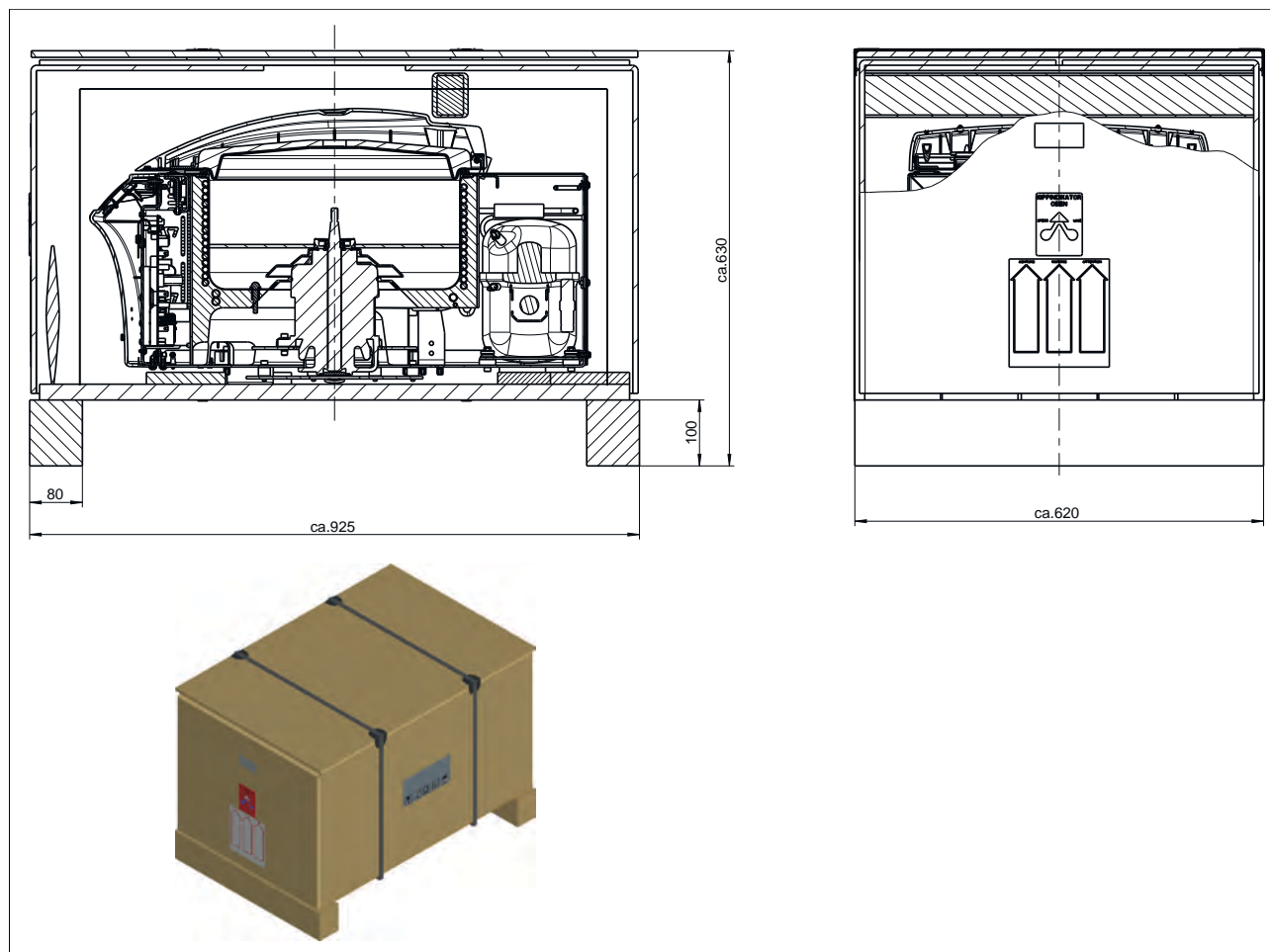

Fig. 10: Transport packaging dimensions

Data	Value	Unit
Outer dimensions (L x W x H)	925 x 620 x 630	mm
Weight	approx. 105	kg

Storage conditions



WARNING

Warning - Impermissible ambient temperature!

If the ambient temperature is outside of the permissible ambient temperature range for the samples, these might be compromised.

- Observe the permissible maximum and minimum ambient temperatures for setting up the device.
- Do not place the device next to heat sources or devices which radiate heat.
- Check the samples after any device overheating to see if they can still be used and take new samples, if necessary.
- Make sure the device is not exposed to direct sunlight.
- Make sure the device is not exposed to frost.
- Maintain the minimum clearance around the device.

- The device can be stored in the original packaging.
- The device may only be stored in dry rooms.
- The storage temperature must be between - 20 °C and + 60 °C.
- The humidity must be non-condensing and must be between 10 % and 80 %.

Transport

- Observe the weight of the device during transport.
- When transporting with a transport aid (e.g. transport cart), this must be able to bear a weight at least 1.6 times the permissible transport weight.
- Secure the device against tipping over and falling down during transport.
- Never transport the device on its side or upside-down.

5 Commissioning

- Set up and level the device at a suitable location so that it is stable. During setup, the required safety zone of 300 mm around the device must be complied with in acc. with IEC 61010-2-020 Ed.2 2006 "Safety requirements for electrical equipment for measurement, control, and laboratory use – Part 2-020: Particular requirements for laboratory centrifuges.



WARNING

During a centrifugation run, no personnel, hazardous substances or objects may be within a safety zone of 300 mm around the device in acc. with IEC 61010-2-020 Ed.2 2006 "Safety requirements for electrical equipment for measurement, control, and laboratory use – Part 2-020: Particular requirements for laboratory centrifuges.

- Ventilation openings may not be blocked. A distance of 300 mm to the air slots and ventilation openings must be complied with.
- Before commissioning, check to make sure the mains voltage is correct according to the nameplate and that the mains cable is connected properly.
- Only trained and instructed personnel may commission and use the device.

Every time before the device is used, make sure that

- the device is dry (no moist residues from cleaning agents, etc.).
- no objects are lying in the centrifuge chamber under the rotor.
- the rotor position corresponds to the home position.
- the accessories are correctly connected to each other (leak-proof) and the rotor is correctly inserted.
- the shown displays are correct.

5.1 Unpacking the device

Personnel:

- Authorized skilled personnel with special instruction

The device is packaged in a box.



When lifting up the device, note the specified weight and only lift the device with a suitable number of helpers to avoid injuries.



WARNING

Warning - Position changed due to vibration!

The device might fall down if the set-up surface vibrates or if it is not flat or stable enough.

- Only place the device on a stable, flat surface.
- The set-up surface must reliably bear the weight of the device.







WARNING

Risk of injury due to parts falling out of the packaging!

When parts fall out of the transport packaging, there is a risk of crushing injuries to extremities.

- Observe the warnings for opening the packaging.
- Only open the packaging at the specified point.

1.  Remove the packaging bands.
2.  Lift up the box and remove the padding.
3.  Remove the accessories.
4.  Set up the device on a stable and flat surface with a suitable number of helpers. Note the weight of the device.



NOTICE

Check the device for any transport damage before commissioning. Do not put the device into operation if there is transport damage or if moisture has penetrated it.

5.2 Setting up, connecting and switching on the device

Setting up the centrifuge



Switching off the device with the device switch does not disconnect this completely from the mains. The device is completely disconnected from the mains by pulling out the mains cable. The mains cable must be freely accessible at all times in order to be able to disconnect the device from the mains at the power socket or device plug.

Personnel:

- Authorized skilled personnel with special instruction



When lifting up the device, note the specified weight and only lift the device with a suitable number of helpers to avoid injuries.



WARNING

Warning - Position changed due to vibration

The device might fall down if the set-up surface vibrates or if it is not flat or stable enough.

- Only place the device on a stable, flat surface.
- The set-up surface must reliably bear the weight of the device.



DANGER

Danger due to the penetration of water or other liquids

When water penetrates into the device, there is a danger of a short circuit and the user suffering an electric shock.

- Prevent water and moisture from penetrating into the device.
- Do not pour liquids into the device interior.
- The device must not stand in the rain.
- Transport is only allowed with suitable transport protection.



WARNING

Warning - Impermissible ambient temperature!

If the ambient temperature is outside of the permissible ambient temperature range for the samples, these might be compromised.

- Observe the permissible maximum and minimum ambient temperatures for setting up the device.
- Do not place the device next to heat sources or devices which radiate heat.
- Check the samples after any device overheating to see if they can still be used and take new samples, if necessary.
- Make sure the device is not exposed to direct sunlight.
- Make sure the device is not exposed to frost.
- Maintain the minimum clearance around the device.
- Make sure that the fan is not blocked.
- Never operate the device in a continuous run.

➔ Set up the device on a stable and flat surface with a suitable number of helpers. Note the weight of the device.

Connecting the device

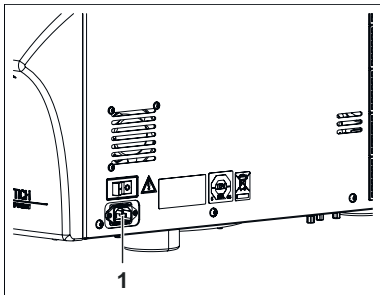

Fig. 11: Power supply connection

1 Mains cable connection

Personnel:

- Authorized skilled personnel with special instruction

1. ➔ A type B residual current circuit breaker must be used if the device is additionally protected with a residual current circuit breaker in the building installation.

When using a different type, the residual current circuit breaker may either not switch off the unit if there is a fault on the unit, or it may switch off the unit even though there is no fault on the unit.

2. ➔



Make sure the operating voltage is correct, as specified on the nameplate.

Connect the mains cable included in delivery to the device plug on the device.

3. ➔ Stick the other end in the socket.

Switching on the device

Personnel:

- Authorized skilled personnel with special instruction

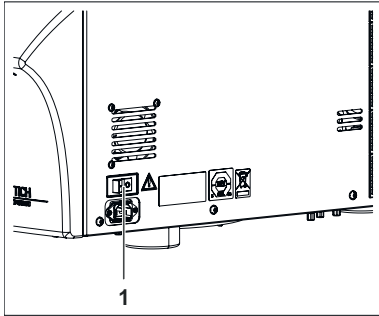

Fig. 12: Device switch

1 Device switch [ON/OFF]

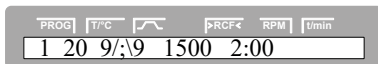

Fig. 13: Start screen

1. ▶ Switch the device on.

▶ The control will start up. The following information is shown on the display:

- Device type
- Software version and mains voltage
- Rotor information about the last operated rotor type
The maximum permissible speed of the rotor is taken by the system.
The maximum speed of the device is limited by the data stored in the rotor code.
In order to be able to make use of the display function of the relative centrifugal force, the centrifugation radius must be input. It is not automatically taken from the rotor code.
- Note regarding the opening of the device / For opened device: Program no. 1 / last loaded program, the last loaded program link.

2. ▶ Open the lid → *Chapter 6.2 'Opening the lid' on page 27.*

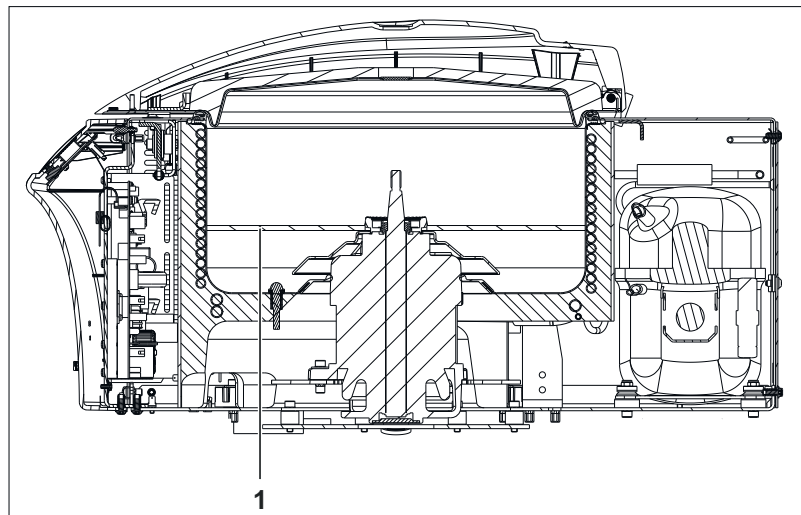

Fig. 14: Transport securing device

1 Transport securing device

3. ▶



NOTICE

Before commissioning the device, remove the transport securing device from the interior.

Remove the transport securing device.

4. ▶ The device is now prepared for rotor installation.



If 'Enter max cycles = <30000>' is displayed after switching on the device, the maximum permissible number of running cycles (specified on the rotor) must first be entered before the centrifugation run can be restarted.



If the speed in the activated program is higher than the maximum rotor speed (Nmax), no centrifugation run can be started. 'N > ROTOR MAX' is displayed → Chapter 9 'Troubleshooting' on page 66.

6 Operation

6.1 Operating elements

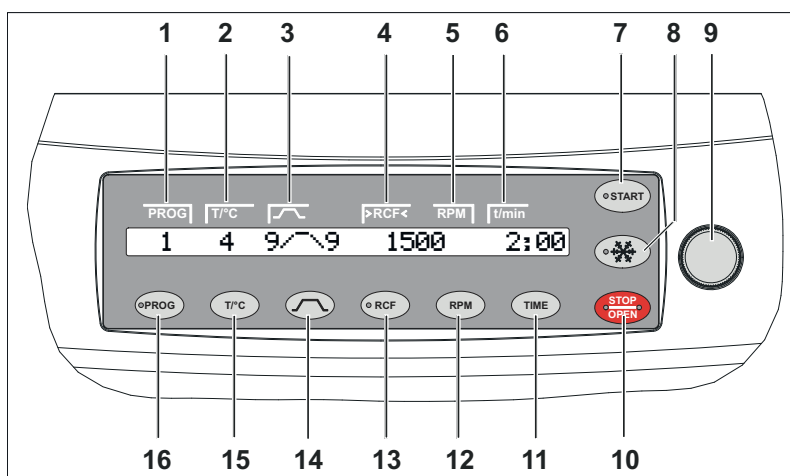

Fig. 15: Control panel

- 1 'Current program' display segment
- 2 'Temperature' display segment
- 3 'Start-up and run-down parameters' display segment
- 4 'Relative centrifugal force' display segment
- 5 'Speed' display segment
- 6 'Runtime' display segment
- 7 [START] key
- 8 [Rotor precooling] key (only for devices with cooling)
- 9 [Adjusting knob]
- 10 [STOP/OPEN] key
- 11 [TIME] key
- 12 [RPM] key
- 13 [RCF] key
- 14 [Start-up and run-down parameters] key
- 15 [T/°C] key (only for devices with cooling)
- 16 [PROG] key



[Adjusting knob]

For setting the individual parameters.

Turning counterclockwise reduces the value. Turning clockwise increases the value.

TIME

[TIME] key

- Runtime, parameter t/hms.
h: hours. Can be set from 1 h to 99 h, in 1-hour increments.
m: minutes. Can be set from 1 min to 59 min, in 1-minute increments.
s: seconds. Can be set from 1 s to 59 s, in 1-second increments.
- Continuous run '@'
- Set the beginning of runtime counting. This setting is only possible when the *'Dual time mode'* function is activated → *Chapter 7.3.5.12 'Dual time mode' on page 62*. This function is deactivated ex works.
 It can be set whether the runtime should begin immediately after the start of the centrifugation run or only start counting after reaching the set speed.
'Timing begins at Start': The runtime begins counting immediately after the centrifugation run begins.
'Timing begins at Speed': The runtime only begins counting after reaching the set speed.
'Timing begins at Speed': This is indicated on the display by the symbol , to the left next to the time.

RPM

[RPM] key

Speed, parameter RPM.

Can be set from 50 RPM to the maximum rotor speed (Nmax), in increments of 10. Maximum rotor speed → *Appendix A 'Rotors and accessories' on page 79*.

RCF

[RCF] key

- Relative centrifugal force, parameter RCF.
 The RCF is displayed in brackets > <. The LED in the button lights up. A number value can be set which results in a speed between 50 RPM and the maximum rotor speed (Nmax). Adjustable in increments of 1.
- Centrifuging radius, parameter RAD. Can be set from 10 mm to 330 mm, in 1-mm increments. Centrifuging radius → *Appendix A 'Rotors and accessories' on page 79*. The centrifuging radius is not automatically taken from the rotor code / rotor information, but must be entered manually.
- Query of the integral RCF. It is only possible to query the integral RCF if the display of the integral RCF is activated → *Chapter 7.3.5.6 'RCF Integral' on page 60*.



[Start-up and run-down parameters] key

- Start-up levels, parameter $_ /$
Level 9 = shortest start-up time, ... level 1 = longest start-up time.
- Start-up time, parameter $/ t$. Adjustable in 1-second increments. The adjustable time range depends on the set speed.
It is only possible to set start-up times when these are activated
➔ Chapter 7.2.2 'Start-up and run-down parameters' on page 45.
- Braking levels, parameter $_ \backslash$
1-9 = linear braking curve.
Level 9, = shortest run-down time, ... level 1 = long run-down time, level 0 = unbraked run-down.
- Run-down time, parameter $\backslash t$.
Adjustable in 1-second increments. The adjustable time range depends on the set speed.
It is only possible to set run-down times when these are activated
➔ Chapter 7.2.2 'Start-up and run-down parameters' on page 45.
- Braking switch-off speed; parameter **N Brake**.
Can be set from 50 RPM to the maximum rotor speed (Nmax), in increments of 10. After reaching this speed, the unbraked run-down occurs.



[T/°C] key

- Can be set in degrees Celsius (°C) or in degrees Fahrenheit (°F).
Adjustment of the temperature unit ➔ Chapter 7.3.5.4 'Temp Unit' on page 59.
- Parameter 'T/°C' = degrees Celsius (°C).
Can be set from -20 °C to +40 °C, in increments of 1 °C.
- Parameter 'T/°F' = degrees Fahrenheit (°F).
Can be set from -4 °F to +104 °F, in increments of 1 °F.
- The lowest reachable temperature depends on the rotor ➔ Appendix A 'Rotors and accessories' on page 79.
- Scroll back in the menus.



[PROG] key

- Call up programs and program links, parameter 'RCL'.
Programs: Program locations 1 to 98 and PREC. Program links: Program locations A to Z.
- Save programs and program links, parameter 'STO'.
99 programs can be saved (program locations 1 to 98 and PREC).
The program location PREC (PRECOOLING) is reserved for the pre-cooling program. The program location 0 acts as a buffer for the centrifugation data of the last centrifugation run. No programs can be stored at this program location.
It is possible to save 25 program linkages (program locations A to Z; there is no program location J). A program linkage can consist of 20 programs.
- Linking programs, parameter 'EDIT'.
- Call up the 'Machine Menu' (keep the key pressed for 8 seconds).
- Select the submenu in the 'Machine Menu'.
- Scroll forward in the menus.



[Rotor precooling] key

Start the centrifugation run to precool the rotor. The LED in the key will be illuminated during the centrifugation run as long as the rotor is turning. The centrifugation run for precooling the rotor is run automatically with the program 'PREC' (PRECOOLING).



[START] key

- Start the centrifugation run. The LED in the key will be illuminated during the centrifugation run as long as the rotor is turning.
- Short-term centrifugation.
Centrifugation is run as long as the key is kept pressed. The LED in the key will be illuminated during the centrifugation run as long as the rotor is turning.
- Save inputs and changes.
- Call up the menus 'Info', 'Operating Time' and 'Settings'.



[STOP/OPEN] key

- End the centrifugation run.
The rotor runs down with a pre-selected run-down parameter. The right LED in the button is illuminated until the rotor is still. After the rotor stops, the left LED in the key will flash. Pressing the key twice triggers the quick-stop function.
- Unlock the lid.
The left LED in the key will go out.
- Exit the parameter input and the menus.
- Trigger the quick-stop function.

6.2 Opening the lid

Personnel:

- Authorized skilled personnel with special instruction



The lid can only be opened if the device is switched on and the rotor is stopped. If it is not possible to open the lid, actuate the emergency release → Chapter 6.9 'Emergency unlocking' on page 38.

To open the lid, proceed as follows:

1. ➤ Switch the device on.
2. ➤ Press the [STOP/OPEN] key on the control panel.
 - The lid unlocks and the left LED of the [STOP/OPEN] key goes out.
3. ➤ Open the lid as far as it can go.

6.3 Closing the lid

Personnel:

- Authorized skilled personnel with special instruction



! WARNING

Risk of crushing!

Do not reach with your hands between the lid and the housing.

To close the lid, proceed as follows:

1. ➤ Close the lid of the device.
2. ➤ Lightly press the lid down.
 - ➔ The lid is locked. The left LED in the [STOP/OPEN] key lights up.

6.4 Quick-stop function

If the [STOP/OPEN] key is pressed twice in a row, the quick-stop function will be triggered.

With the quick-stop function, the run-down takes place at braking level ;_ 9 (shortest run-down time). Braking level 9 is displayed. If braking level 0 was preselected, the run-down takes place at braking level ;_ 9d. At braking level 9d, the run-down time is longer than at braking level 9 due to technical reasons.

6.5 Removing and installing the rotor

Rotor removal

Personnel:

- Authorized skilled personnel with special instruction

To remove the rotor, proceed as follows:

1. ➤ Unlock and open the lid ➔ Chapter 6.2 'Opening the lid' on page 27.
2. ➤ Switch off the device with the device switch.

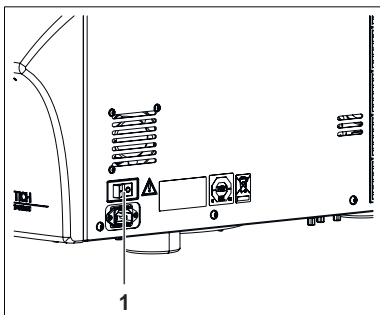

Fig. 16: Device switch

1 Device switch [ON/OFF]

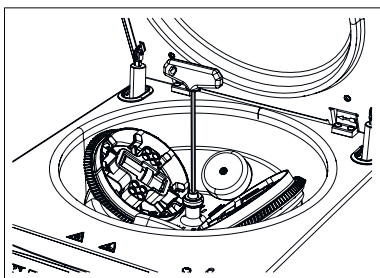

Fig. 17: Loosening the fastening screw of the rotor

3. ➤ Hold the rotor firmly with one hand and loosen the fastening screw of the rotor by multiple turns counterclockwise using the Allen key included in delivery until you can remove the rotor (the fastening screw cannot be removed).
4. ➤ Remove the Allen key.

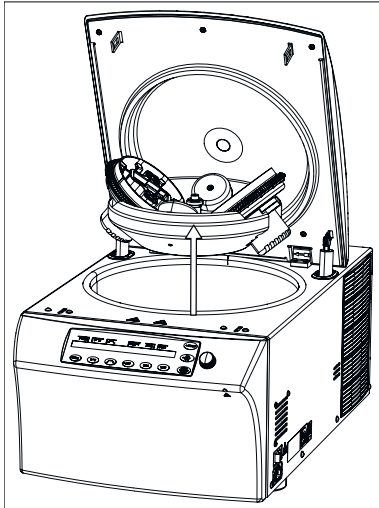

Fig. 18: Removing the rotor

5. → Carefully remove the rotor upward and out of the device.
 - ➔ The interior (centrifuge chamber) is now accessible.

Rotor installation

Personnel:

- Authorized skilled personnel with special instruction



NOTICE

If the rotor is incorrectly installed or fastened, it could end up coming loose.

When installing the rotor, make sure that the driver of the rotor shaft is sitting correctly in the rotor groove.

On the top side of the rotor, there are markings which mark the position of the groove in the rotor.

The screw for fastening the rotor must be tightened sufficiently hand-tight so that the rotor does not come loose during operation.



Fig. 19: Rotor and rotary unit

- 1 Arrow marking on the rotary unit
- 2 Rotor centre

1. →



When installing a rotor for the dual centrifugation, note that it is imperative that the two rotor cavities be positioned symmetrically.

Align the rotation units such that their arrow markings (1) point toward the centre (2).

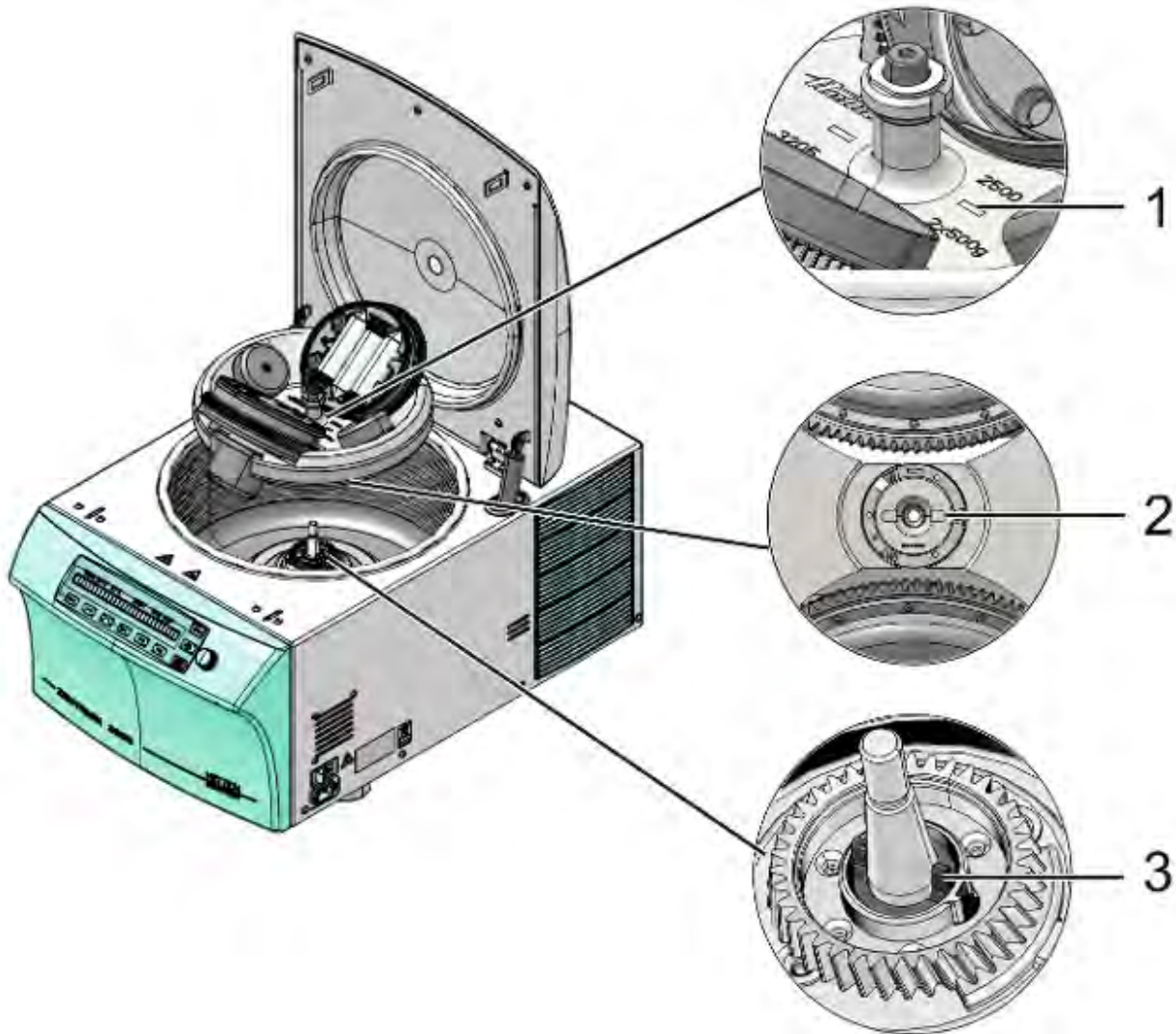

Fig. 20: Installing the rotor

- 1 Marking on the rotor
- 2 Bottom side of rotor with groove
- 3 Rotor shaft with lateral driver

2. ➔ Place the rotor on the rotor shaft such that the groove markings on the rotor (1) and the driver of the rotor shaft (3) point in one direction.

The correct alignment of the rotor is absolutely essential, since this defines the correct alignment of the adapter with the sample containers. This minimizes unbalances and prevents damage to the machine.

3. ➔ Hold the rotor firmly with one hand and tighten the fastening screw of the rotor hand-tightly by multiple turns in the clockwise direction using the Allen key included in delivery.

4. ➔ Put the device into operation.

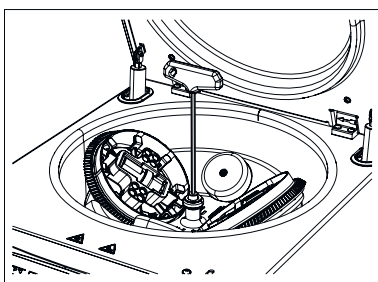

Fig. 21: Tightening the fastening screw of the rotor

6.6 Loading the rotor

6.6.1 Loading a rotor for classical centrifugation



Standard centrifuge containers made of glass can be stressed up to RZB 4000 (DIN 58970 Part 2).



Fig. 22: Rotor is loaded symmetrically.



Fig. 23: Rotor is evenly loaded

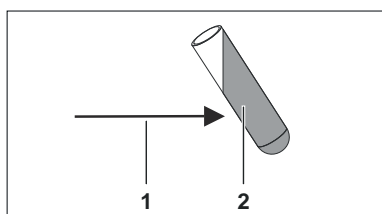

- 1 Centrifugal force
- 2 Liquid

- Check the rotor to make sure it is seated firmly.
- For swing-out rotors, all rotor places must be occupied with the same hangers. Certain hangers are labelled with the number of the rotor place. These hangers may only be used in the corresponding rotor place. Hangers which are labelled with a set number, e.g. S001/4, may only be used in a set.
- The rotors and hangers may only be loaded symmetrically. The centrifuge containers must be distributed evenly over all rotor places. For permissible combinations, see → Appendix A 'Rotors and accessories' on page 79. In the case of angle rotors, all possible places of the rotor must be loaded. See → Appendix A 'Rotors and accessories' on page 79.
- On certain hangers, the weight of the maximum load or the weight of the maximum load and the maximum weight of the completely loaded hanger is specified. These weights must not be exceeded. The weight specification of the maximum load includes the total weight of the reducing adapter, frame, centrifuge container and contents.
- For containers with rubber inlays, there must always be the same number of rubber inlays under the centrifuge containers.
- The centrifuge containers may only be filled outside of the centrifuge.
- The maximum filling amount of the centrifuge containers specified by the manufacturer must not be exceeded. In the case of angle rotors, the centrifuge containers may only be filled such that no liquid can be hurled out of the containers during the centrifugation run.
- When loading the angle rotors, no liquid may enter them or the centrifuge chamber.
- When loading the hangers of the swing-out rotors and when swinging out the hangers during the centrifugation run, no liquid may get into the hangers or centrifuge chamber.
- To keep the weight differences inside the centrifuge containers to a minimum, make sure the filling amount in the containers is even.

6.6.2 Loading a rotor for dual centrifugation



NOTICE

When loading, make sure that the two rotary units are loaded evenly.

The difference in the load of the rotary units may be max. 5 g.

The two rotary units must be evenly loaded.

Sealing the containers

Sample containers must be firmly sealed, even more strongly than required for other laboratory work, since they are shaken very vigorously upside-down. Only use containers approved by the manufacturer for the respective application.

- Clamp small containers firmly between the fingers and tighten as tightly as possible.
- The large sample containers must be clasped with both hands in order to seal them tightly enough that nothing escapes when shaking upside-down.

Weight

The sample containers must be weighed. They must have the same weight. The rotary unit load must not exceed **500 g** (samples + adapters + any sample receptacles). The load difference between the two rotor cavities may be max. **5 g**. The sample containers should be filled to about max. **50-70 %**.

As with standard centrifugation, close attention must also be paid to the loading weight for dual centrifugation. It is not sufficient to estimate the weight of the sample containers or to use their scaling to do this.

Before a filled adapter is inserted in the rotor cavity, it must be ensured by weighing that both filled adapters weigh the same. All samples must have the same content and also the same weight.

Arrangement of the samples

If not all positions of the adapter are used, the same numbers of sample containers must be distributed over the two adapters, whereby only one (mirrored) symmetrical arrangement may exist inside the adapter.

There must be (mirrored) symmetry both within each rotary unit, as well as among the rotary units.

The symmetry among the rotary units is ensured through the use of adapters and their correct alignment.

Example: Adapter for 50 ml reaction vessels

Incorrectly loaded:



There is no symmetry within the rotary unit in the first and second figures.

There is an unequal number of containers in the rotary units in the third figure.

Correctly loaded:

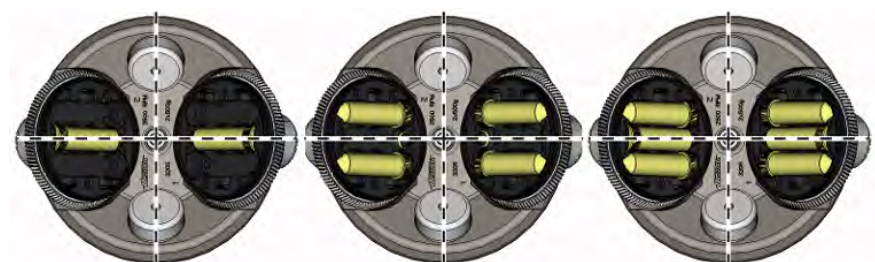

Correct symmetry within (horizontal mirror axis) and among (vertical mirror axis) the rotary units, as well as identical number of samples at right and left.

Example: 4 adapters for 2 ml tube containers



Für 2 ml RöhrengeläÙe gibt es für jede Dreheinheit einen zweiteiligen Adapter.

10 tube containers can be stuck in each adapter.

For a sample number less than or equal to 20, only the lower adapters are used. For a sample number greater than 20, the two upper adapters are required.

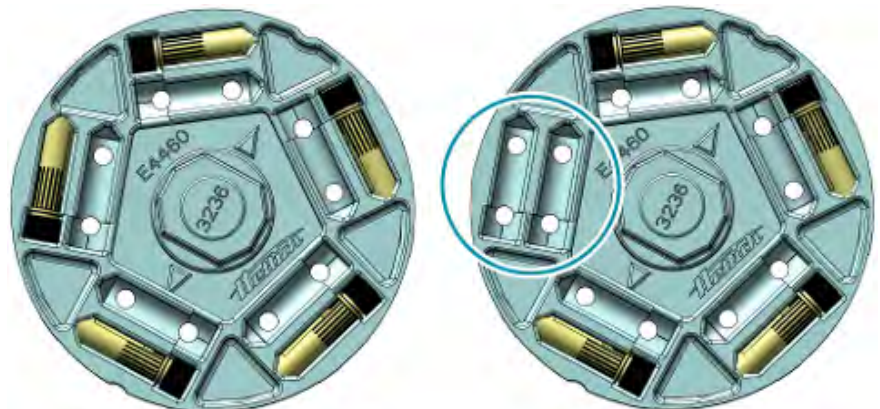

First occupy the outerlying positions.

For uneven numbers, a max. of one position can remain unoccupied when the container weighs less than 5 g.



NOTICE

Compensation containers can also be used. But these should be filled with a suitable sample material so that they cannot overheat. Ideally, this is a blank sample identical to the samples being processed.

Never use compensation containers filled with water, since liquids with low viscosity can strongly heat up even at low speed, which would result in the bursting of the containers, and therefore to device damage.

What to do at the start

! NOTICE

What to do in the event of unbalance

The centrifuge is equipped with an unbalance switch like every commercially available laboratory centrifuge.

If strong vibrations should result from incorrect loading or process-intrinsic operations which the unbalance switch still tolerates, but still leads to increased wear, the process must be ended by pressing the [STOP/OPEN] key twice.

Observe the device for its unbalance behavior until it has reached the specified maximum speed.

6.6.3 Handling of bio-safety systems

i *Bio-safety systems may only be used when they are dry.*

Each time before using the bio-safety system, all parts of the bio-safety system must be visually inspected for damage. In addition, the sealing ring(s) of the bio-safety system must be checked to make sure they are in the correct installation position.

Damaged parts of the bio-safety system must be exchanged immediately.

Damaged bio-safety systems are no longer microbiologically sealed.

To ensure leak-tightness, the lid of the bio-safety system must be correctly sealed.

Available bio-safety systems can be found in the attachment → Appendix A 'Rotors and accessories' on page 79. If in doubt, you can get the information you need from the manufacturer.

6.6.3.1 Opening and closing the lid of bio-safety systems

6.6.3.1.1 Lid with screw closure

To close the lid, proceed as follows:

1. → Place the lid on the hanger.
2. → Tightly seal the lid by hand by turning it clockwise.

To open the lid, proceed as follows:

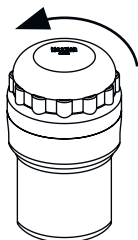
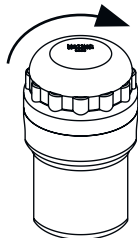

→ Turn the lid by hand counterclockwise until the lid can be removed from the hanger.

6.6.3.2 Storage of bio-safety systems



To prevent damage to the sealing rings during storage, bio-safety systems may only be stored with the lid open.

6.7 Starting centrifugation



A centrifugation run can be aborted at any time by pressing the [STOP/OPEN] key.

During a centrifugation run, parameters can be selected and changed → 'Changing settings during the centrifugation run' on page 41.

The [RPM] and [RCF] buttons can be used to switch between the 'RPM' and 'RCF' display at any time. Switching is not possible if program linkages are being used. If the 'RCF' display is used, the centrifuging radius must be input.

If 'OPEN OEFFNEN' is displayed, it is only possible to continue to operate the device after opening the lid one time.

Operating errors and malfunctions are displayed → Chapter 9 'Troubleshooting' on page 66.

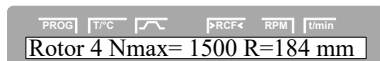

Rotor detection is carried out after each centrifugation run is started.

If the rotor was changed, the centrifugation run is aborted after rotor detection. The rotor code (rotor types), the maximum rotor speed (Nmax) and a centrifuging radius (R) of the newly detected rotor are displayed, e.g., 'Rotor 4 Nmax= 2500 R=184 mm'.



If the maximum speed of the used rotor is less than the set speed, the speed is limited to the maximum rotor speed. In this case, the program location number is displayed in parentheses '()'.

To start a centrifugation run, proceed as follows:

1. → Load the corresponding program → Chapter 7.1.1 'Calling up/loading program (RCL 1-99)' on page 41 or program link → Chapter 7.1.3 'Calling up/loading a program link (RCL A-Z)' on page 42.
2. → Load the rotor with the samples → Chapter 6.6 'Loading the rotor' on page 31.
3. → Close the lid of the device.
4. → Press the [START] key to start the centrifugation run.



For devices with cooling, the rotor precooling can also be started by pressing the [Rotor precooling] key.



If the cycle counter is activated, the number of running cycles (centrifugation runs) of the used rotor code is briefly displayed after opening the lid, e.g., 'CYCLES 5120 of 30000' → 'Cycle counter' on page 56.



During the centrifugation run, the rotor speed or the RCF value, the temperature in the centrifuge chamber and the remaining time are displayed.

Short-term centrifugation



A short-time centrifugation is not possible if program linkages are being used.

The run-down is performed with the selected run-down parameters → Chapter 7.2.2.2 'Braking stage and run-down time' on page 46.

To perform short-term centrifugation, proceed as follows:

1. Load the rotor with the samples → Chapter 6.6 'Loading the rotor' on page 31.
2. Close the lid of the device.
3. Keep the [START] key pressed. When the [START] key is released, the sequence is stopped.
 - The LED in the [START] key flashes until the rotor is read in; then the LED is illuminated. The timer begins at '00:00'.



During the centrifugation run, the rotor speed or the RCF value, the temperature in the centrifuge chamber and the elapsed time are displayed.

4. Release the [START] key again to end the centrifugation run.
 - ■ The run-down parameters are displayed.
5. Once the rotor has come to a standstill, the left LED in the [STOP/OPEN] key starts to flash and 'OPEN OEFFNEN' appears on the display.
6. You can now open the lid by pressing the [STOP/OPEN] key.

6.8 Dual centrifugation: Validating application



ZentriMix applications are to be carried out according to the protocol authorized by the manufacturer.

Every application not described by the manufacturer protocol or any deviation from the standard manufacturer protocol must be validated before use.

The protocols typical for your applications are delivered to you with the device.

Required validation steps:

- Evaluation of a potential hazard, such as the overheating of the sample or sample container, gas formation from the sample, breakage of the sample container due to mechanical, thermal or chemical overload.
To do this, the device parameters are to be increased in small increments in order to be able to notice potential hazards early enough.
- Repetition: Due to repeated runs, the rotor might increasingly heat up, which can no longer be compensated by the cooling unit.
If such a sequence of runs is planned, the developed protocol must be tested for this to see whether repeated executions can lead to the device dangerously overheating or whether the device must first reach its original temperature again between two runs.
- Check of the desired effect on the sample.

Personnel:

- Authorized skilled personnel with special instruction

1.  Define the starting parameters:



NOTICE

The runtime must be selected depending on the process, but should not exceed 30 minutes.

Very fluid samples can heat up very strongly under certain circumstances, which could result in the sample container bursting. Therefore, increase the duration and/or speed of the run gradually when developing a new method and observe the heating of the sample.

During the validation of an application, the cooling unit of the device must be active. → Chapter 6.10 'Cooling' on page 39.

2.  Select a start-up level between '5' and '9'; the braking level should always be set to '9' → Chapter 7.2.2 'Start-up and run-down parameters' on page 45.



– If the process is thermosensitive, you should pre-cool the ZentriMix → Chapter 7.2.6 'Precooling of the rotor' on page 51.

– For frequently recurring processes, we recommend that you save a program for this → Chapter 7.1.2 'Save programs (STO 1-99)' on page 41.

3. 



Monitor the device until the set speed has been reached. Check whether unbalance can be observed through the sight glass in the device lid.

Start the run by pressing the [START] key.

**NOTICE****What to do in the event of unbalance**

The ZentriMix is equipped with an unbalance switch like every commercially available laboratory centrifuge.

If strong vibrations should result from incorrect loading or process-intrinsic operations which the unbalance switch still tolerates, but still leads to increased wear, the process must be ended by pressing the [STOP/OPEN] key twice.

6.9 Emergency unlocking

Personnel:

- Authorized skilled personnel with special instruction



In the event of a power failure, the lid of the device cannot be opened. Emergency unlocking must be done by hand.

**DANGER****Danger due to rotor moving with high kinetic energy!**

There is a risk of injury if the lid is opened via the emergency release during device operation.

- Only open the device via the emergency release when the device is switched off.
- Before the emergency release, make sure that the device rotor has stopped.

To release the lid in an emergency, proceed as follows:

1. ➤ Switch off the device and pull out the mains plug.
2. ➤ Make sure the rotor is stopped by looking through the viewing window in the lid.

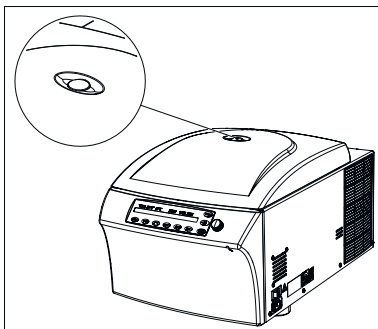

Fig. 24: Viewing window in the lid (figure is an example)

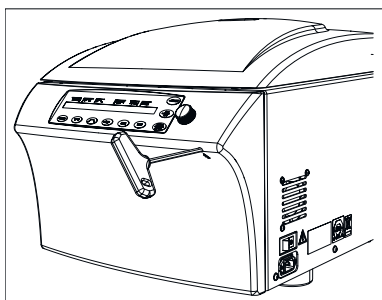

Fig. 25: Emergency release (figure is an example)

3. ➤ Insert the Allen key (included in delivery as an accessory) horizontally into the emergency release opening on the front side and carefully rotate by one-half turn in the clockwise direction until the lid can be opened.
 - The lid releases and springs open slightly.
4. ➤ Remove the Allen key from the opening.
5. ➤ Completely open the lid.



If the left LED in the [STOP/OPEN] flashes after switching the device on again, press the [STOP/OPEN] key until the motor-driven lid lock assumes its home position again (open).

6.10 Cooling



The temperature can be set from -20 °C to +40 °C / -4 °F to +104 °F. The device displays the temperature of the centrifuge chamber. The actual temperature of the sample can vastly differ from the displayed temperature.

When the rotor is at a standstill, with the lid closed, the centrifuge chamber is cooled to the preselected temperature if this is lower than 20°C / 68°F. During standby cooling, the preselected temperature is displayed.



Dual centrifugation should fundamentally be applied with cooling in order to dissipate the heat that arises during the process and to prevent the samples from overheating.

7 Software description



All settings and queries are carried out via the keyboard. The corresponding menus are selected by pressing keys or key combinations.

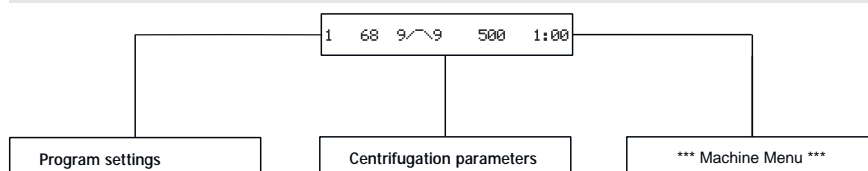

Fig. 26: Main menu

After switching on the device, the start screen appears. Here, the display changes between the product type of the device, the software version and, depending on the setting, the last loaded program or program location no. 1.

The descriptions of the individual menu items can be found in the following chapters. The chapter structure is identical to the menu structure on the device.



The screen displays in these operating instructions are examples and can therefore deviate from the actual displays on the device.

7.1 Program settings

Overview

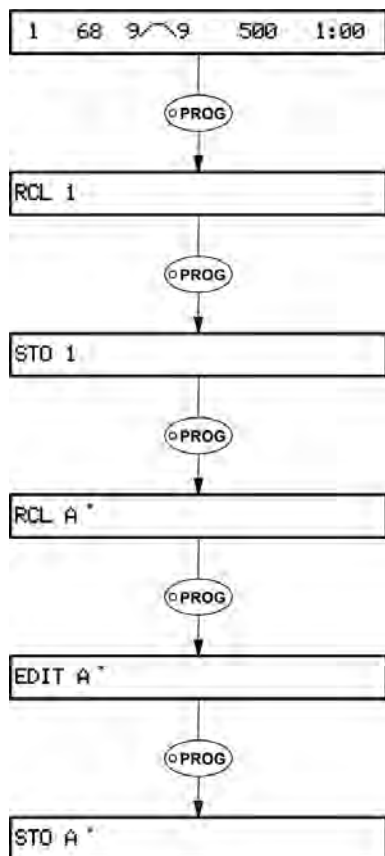

Fig. 27: Programs and program links

The device has over 99 predefined programs at its disposal. These can be adapted according to the usage requirements. The running of individual programs can be successively stored by means of program links.



If parameters are changed, the program location number is displayed in parentheses '()'. This means that the centrifugation data on the display no longer agrees with the stored centrifugation data of the program location.



* The display of program links is only possible if the 'Multi programs' function is activated in the 'Settings'.

- RCL: Recall Program - Call up program or program link
- STO: Store Program - Save the program or program link
- EDIT: Edit Program - Edit program link
- 1-99: Program
- A-Z: Program linkage

Automatic buffer

Program location '0' acts as a buffer for the centrifugation data of the last centrifugation run.

No programs can be stored at this program location. After every start of a centrifugation run, the centrifugation data used for the run is automatically stored at program location '0' and can be called up.

Write protection for programs



The programs can be protected against unintentional modification.



The write protection can be activated/deactivated as follows when the rotor is at a standstill:

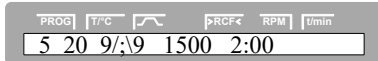
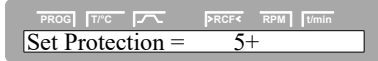

Changing settings during the centrifugation run

1. Call up the program for which you would like to activate/deactivate write protection → Chapter 7.1.1 'Calling up/loading program (RCL 1-99)' on page 41.
2. Press the *[PROG]* key.
3. Keep the *[PROG]* pressed for 8 seconds.
4. Set '+' or '-' using the *[adjusting knob]*.
 - '+' Program is write-protected
 - '-' Program is not write-protected.
5. Press the *[START]* key to save the setting.



It is not possible to change the settings during the centrifugation run if program links are used.

The runtime, speed, relative centrifugal force (RCF), the start-up and run-down parameters as well as the temperature (only for device with cooling) can be changed during the centrifugation run.

Change the value of the desired parameter → Chapter 7.2 'Centrifugation parameters' on page 44: The changed setting is stored at program location '0' → 'Automatic buffer' on page 40. The original program is not overwritten. The program location number is displayed in parentheses (''). This means that the centrifugation data on the display no longer agrees with the stored centrifugation data of the program location.

7.1.1 Calling up/loading program (RCL 1-99)



To call up (load) a program, proceed as follows:

1. Press the *[PROG]* key.
2. Use the *[adjusting knob]* to set the desired program location.



If a '+' is displayed after the program location, the data is write-protected.

In this case, the write protection has been removed first before saving is possible → 'Write protection for programs' on page 40.

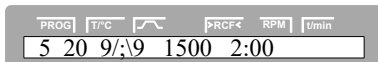
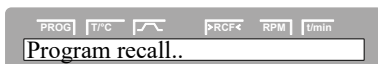

3. Press the *[START]* key.
4. You can now run the loaded program with the lid closed with the *[START]* key.

7.1.2 Save programs (STO 1-99)



The previous program location data will be overwritten when the new data is saved. If 'Protected !!' is displayed, the data at the program location is write-protected and will not be saved.

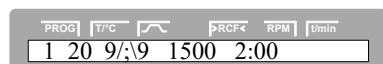

To save new programs, proceed as follows:

1. Press the *[PROG]* key until STO 1 is displayed.
2. Use the *[adjusting knob]* to set the desired program location.



If a '+' is displayed after the program location, the data is write-protected.

In this case, the write protection has be removed first before saving is possible → 'Write protection for programs' on page 40.



3. Press the *[START]* key.



4. You can now run the saved program with the lid closed with the *[START]* key.

7.1.3 Calling up/loading a program link (RCL A-Z)

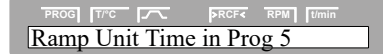
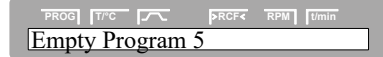

If 'N > ROTOR MAX in Prog', 'Runtime 00:00 in Prog', 'Empty Program' or 'Ramp Unit Time in Prog' is displayed for program links, a centrifugation run cannot be started → Chapter 9 'Troubleshooting' on page 66.



"Program linkage" can be used to link several centrifuge operations together.

A program link is only possible if this is activated (parameter 'Multi programs = on' → Chapter 7.3.5.8 'Multi programs' on page 61).



To call up (load) a program link, proceed as follows:



1. Press the *[PROG]* key until 'RCL A' is displayed.



2. Use the *[adjusting knob]* to set the desired program location.

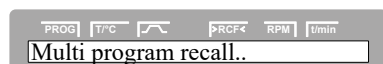

3. Press the *[START]* key.

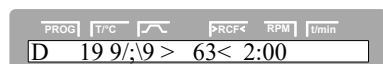

4. You can now run the loaded program link with the lid closed with the *[START]* key.

7.1.4 Editing a program link (EDIT A-Z)



It is possible to save 25 program linkages (program locations A to Z; there is no program location J). A program linkage can consist of no more than 20 programs.

The speed adjustment from one program to the next one is always done in a program linkage with the start-up parameter of the next program.

No continuous run programs or programs with start-up and run-down times (parameters $_ / t$ and $\wedge t$) can be linked.

No centrifugation parameters can be changed in a program link. A parameter modification is only possible in the individual programs.

The total runtime of the program link and the runtime of the currently running program can be called up during the centrifugation run with the [TIME] key.

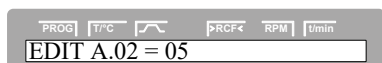
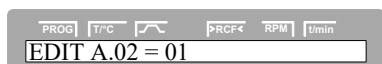
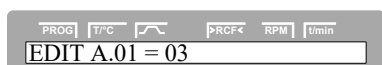
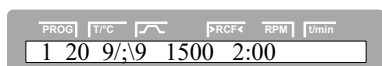

To create or change a program link, proceed as follows:

1. Press the [PROG] key until 'EDIT A' is displayed.
2. Use the [adjusting knob] to set the desired program location.
3. Press the [START] key.
4. Set the first program for the program link with the [adjusting knob].
5. Press the [PROG] key.
6. Set the next program for the program link with the [adjusting knob].
7. Press the [PROG] key.
8. Repeat the previous steps until all desired programs are linked.



After the last program, add a program with 'END'.

For program linkages which consist of 20 programs, program, 'END' cannot be set after the 20th Program and can be omitted in this case.

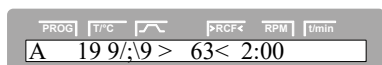

9. Press the [START] key.
10. Use the [adjusting knob] to set the desired program location.
11. Press the [START] key.
12. You can now run the loaded program link with the lid closed with the [START] key.

7.1.5 Saving a program link (STO A-Z)

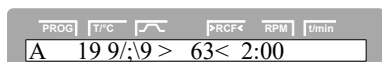

In order to save the current program link (e.g. as a copy), proceed as follows:

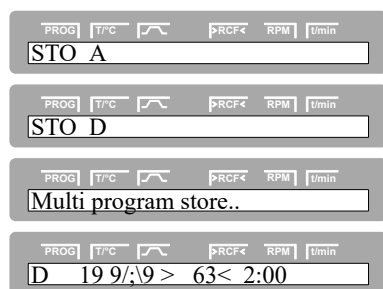

1. ➔ Press the *[PROG]* key until 'STO A' is displayed.
2. ➔ Use the *[adjusting knob]* to set the desired program location.
3. ➔ Press the *[START]* key.
4. ➔ You can now run the saved program link with the *[START]* key with the lid closed.

7.2 Centrifugation parameters

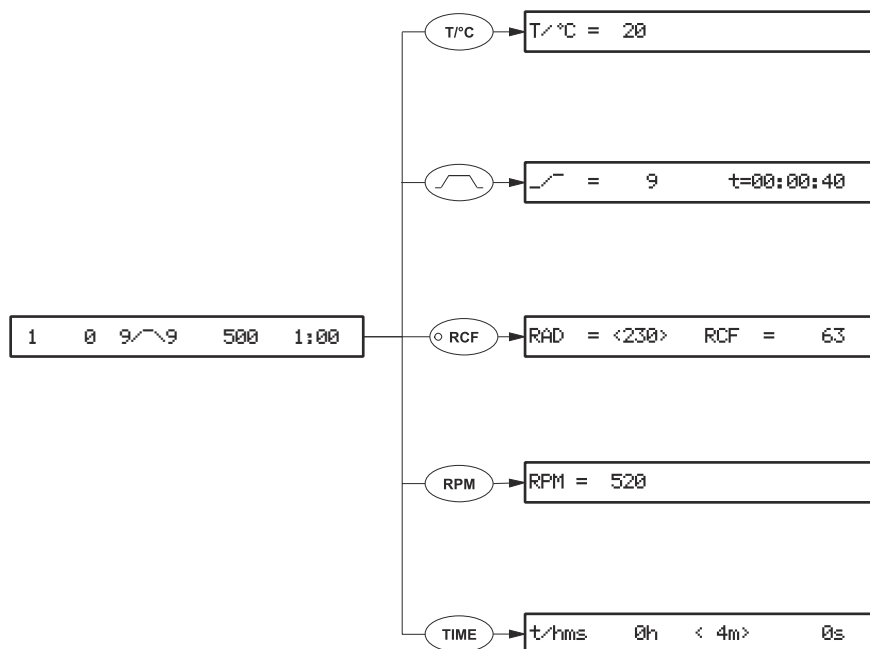

Fig. 28: Centrifugation parameters



If no key is pressed for 8 seconds after selection or during parameter input, the previous values are shown on the display. The parameters must then be input again.

If multiple parameters are entered, the *[START]* key may only be pressed after setting the last parameter in order to accept all changes.

The input of parameters can be aborted at any time by pressing the *[STOP/OPEN]* key. In this case, the settings are not stored.



If parameters are changed, the program location number is displayed in parentheses '()'. This means that the centrifugation data on the display no longer agrees with the stored centrifugation data of the program location.

7.2.1 Temperature (t/°C)



The temperature can only be set for devices with a cooling unit.

The temperature can be input in degrees Celsius (°C) or degrees Fahrenheit (°F).

Setting the temperature unit → Chapter 7.3.5.4 'Temp Unit' on page 59. If degrees Fahrenheit (°F) is set as the temperature unit, the letter 'F' appears after the temperature value on the display.

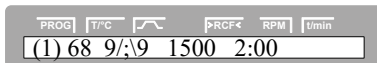
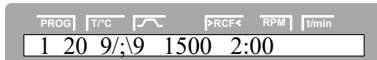

To set the temperature, proceed as follows:

1. ➤ Press the $[T/°C]$ key.
2. ➤ Use the *[adjusting knob]* to set the desired value.
3. ➤ Press the $[START]$ key or $[T/°C]$ key to accept the value.
4. ➤ Save the program → Chapter 7.1.2 'Save programs (STO 1-99)' on page 41.

7.2.2 Start-up and run-down parameters



The set start-up and run-down parameters are displayed.

The start-up and run-down parameters can be activated/deactivated → Chapter 7.3.5.5 'Ramp Unit' on page 60.



x (l)

1-9 = start-up stage, t = start-up time

y (l)

1-9 = braking level, 0 = unbraked run-down, t = run-down time

7.2.2.1 Start-up stage and start-up time



It is only possible to set start-up times when these are activated → Chapter 7.3.5.5 'Ramp Unit' on page 60.



If a start-up time is set which is longer than the running time, no centrifuge run can be started. 'Acc time > Run time' is displayed → Chapter 9 'Troubleshooting' on page 66.

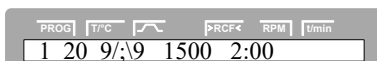

To set the start-up level and start-up time, proceed as follows:



1. ➤ Press the *[Start-up and run-down parameters]* key.



2. ➤ Set the start-up level with the *[adjusting knob]*.



3. ➤ Press the *[TIME]* key.
R
Indicates which start-up level corresponds to the set start-up time.



4. ➤ Set the start-up time with the *[adjusting knob]*.
5. ➤ To accept the settings, press the *[START]* key.
6. ➤ Save the program ➔ *Chapter 7.1.2 'Save programs (STO 1-99)' on page 41.*

7.2.2.2 Braking stage and run-down time



No B-brake stages can be set for this device. It is not possible to activate the B braking levels in the 'Settings' menu (parameter 'B-Ramp = off'). B-brake stages are similar to an exponential braking curve.

It is only possible to set run-down times when these are activated ➔ *Chapter 7.3.5.5 'Ramp Unit' on page 60.*

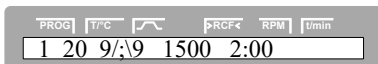

To set the braking level and run-down time, proceed as follows:

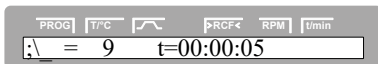

1. ➤ Press the *[Start-up and run-down parameters]* key until the braking level and run-down time are displayed.



2. ➤ Set the braking level with the *[adjusting knob]*.



3. ➤ Press the *[TIME]* key.
R
Indicates which start-up level corresponds to the set start-up time.



4. ➤ Set the run-down time with the *[adjusting knob]*.

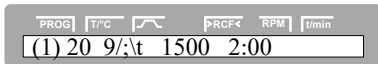

5. ➤ To accept the settings, press the *[START]* key.
6. ➤ Save the program ➔ *Chapter 7.1.2 'Save programs (STO 1-99)' on page 41.*

7.2.2.3 N Brake



If the braking switch-off speed is entered, the braking is aborted at the input value ➔ *Chapter 7.2.2.2 'Braking stage and run-down time' on page 46.*

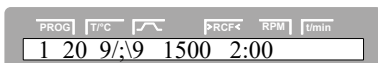

To set the braking switch-off speed, proceed as follows:

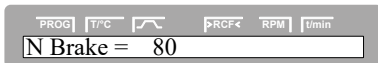

1. ➤ Press the *[Start-up and run-down parameters]* key until the parameter 'N Brake' is displayed.

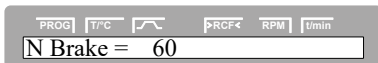

2. ➤ Set the braking switch-off speed with the *[adjusting knob]*.

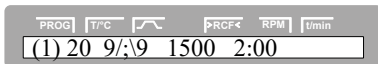

3. ➤ To accept the settings, press the *[START]* key.
4. ➤ Save the program ➔ *Chapter 7.1.2 'Save programs (STO 1-99)' on page 41.*

7.2.3 RCF and RAD



The relative centrifugal force (RCF) depends on the centrifuging radius (RAD). Before setting the relative centrifugal force (RCF), the centrifuging radius (RAD) must be set.

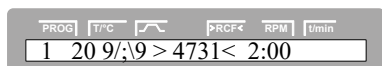

To set the relative centrifugal force (RCF) and the centrifuging radius (RAD), proceed as follows:

1. ➤ Press the *[RCF]* key.
 - ➡ The LED in the *[RCF]* key will light up and the RCF value will be displayed
2. ➤ Press the *[RCF]* key.
3. ➤ Set the centrifuging radius (RAD) with the *[adjusting knob]*.
When the centrifuging radius (RAD) is changed, the value of the centrifugal force (RCF) is automatically adapted.
4. ➤ Press the *[RCF]* key.
5. ➤ Set relative centrifugal force (RCF) with the *[adjusting knob]*.
6. ➤ To accept the settings, press the *[START]* key.
7. ➤ Save the program ➡ Chapter 7.1.2 'Save programs (STO 1-99)' on page 41.



Only by storing the set RCF value will the RPM value resulting from that be accepted.

Querying the integral RCF



The integral RCF is a measure for the sedimentation effect ($\int r^2 dt$). This number value is for comparing centrifugation runs.



It is only possible to query the integral RCF if the display of the integral RCF is activated. ➡ Chapter 7.3.5.6 'RCF Integral' on page 60.

The integral RCF is not saved. The integral RCF is deleted after starting the next centrifugation run or after switching off the device.

If the function 'Timing begins at Speed' is activated, the calculation of the integral RCF only begins after the set speed is reached.

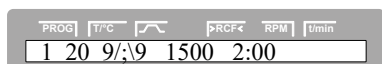

To query the integral RCF, proceed as follows:

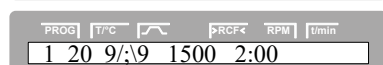
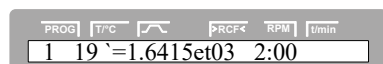

1. ➤ Press the *[RCF]* key.
 - ➔ The LED in the *[RCF]* key is illuminated.
2. ➤ Press the *[RCF]* key until the integral RCF is displayed.
3. ➤ Press the *[RCF]* key to go back to the centrifugation parameters.

7.2.4 Speed (RPM)



When centrifuging at the maximum speed, the density of the materials or material mixtures may not exceed 1.2 kg/dm³. The speed must be reduced for materials or mixtures of materials with a higher density.

The permissible speed can be calculated using the following formula:

$$\text{Reduced speed } (n_{\text{red}}) = \sqrt{\frac{1.2}{\text{higher density } \left[\frac{\text{kg}}{\text{dm}^3} \right]}} * \text{maximum speed [RPM]}$$

Maximum speed 4000 RPM,
density 1.6 kg/dm³

$$n_{\text{red}} = \sqrt{\frac{1,2 \frac{\text{kg}}{\text{dm}^3}}{1,6 \frac{\text{kg}}{\text{dm}^3}}} * 4000 \text{ RPM} = 3464 \text{ RPM}$$



In the exceptional case that the maximum load indicated on the hanger is exceeded, the speed must also be reduced.

The permissible speed can be calculated using the following formula:

$$\text{Reduced speed } (n_{\text{red}}) = \sqrt{\frac{\text{maximum load [g]}}{\text{actual load [g]}}} * \text{maximum speed [RPM]}$$

Maximum speed 4000 RPM,
maximum load 300 g, actual
load 350 g

$$n_{\text{red}} = \sqrt{\frac{300 \text{ g}}{350 \text{ g}}} * 4000 \text{ RPM} = 3703 \text{ RPM}$$

If in doubt you should obtain clarification from the manufacturer.



If the speed in the activated program is higher than the maximum rotor speed (Nmax), no centrifugation run can be started. 'N > ROTOR MAX' is displayed ➔ Chapter 9 'Troubleshooting' on page 66.



Dual centrifugation:

The maximum permissible speed of the applications depends on the samples and sample containers. Every sample container is approved only up to a certain rotational speed depending on the design and application; this must not be exceeded under any circumstances!

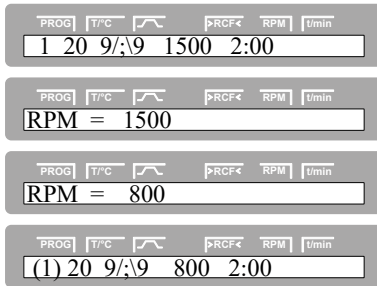

To set the speed (RPM), proceed as follows:

1. ➤ Press the *[RPM]* key.
2. ➤ Use the *[adjusting knob]* to set the desired value.
3. ➤ To accept the settings, press the *[START]* key.
4. ➤ Save the program ➔ Chapter 7.1.2 'Save programs (STO 1-99)' on page 41.

7.2.5 Runtime (t/hms)

Runtime (t/hms)

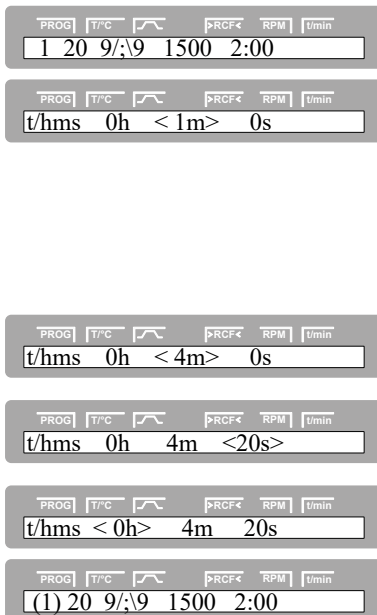

To set the runtime, proceed as follows:

1. ➤ Press the *[TIME]* key.



The value shown in parentheses can be changed.

2. ➤ Set the minutes with the *[adjusting knob]*.
3. ➤ Press the *[TIME]* key.
4. ➤ Set the seconds with the *[adjusting knob]*.
5. ➤ Press the *[TIME]* key.
6. ➤ Set the hours with the *[adjusting knob]*.
7. ➤ To accept the settings, press the *[START]* key.
8. ➤ Save the program ➔ Chapter 7.1.2 'Save programs (STO 1-99)' on page 41.

Start of runtime timer

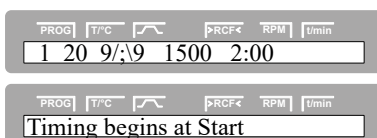

*The start of the runtime timer can only be set if the 'Dual time mode' function is activated ➔ Chapter 7.3.5.12 'Dual time mode' on page 62. The function is **deactivated** ex works.*

To set the runtime timer, proceed as follows:

1. ➤ Press the *[TIME]* key until 'Timing begins at Start' / 'Timing begins at Speed' is displayed.

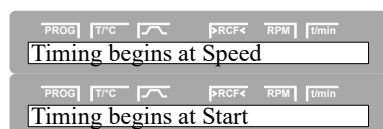

2. → With the [adjusting knob], set 'Timing begins at Start' / 'Timing begins at Speed'.

'Timing begins at Start' The runtime timer begins immediately after the centrifugation run starts.

'Timing begins at Speed' The runtime only begins counting after reaching the set speed.



If 'Timing begins at Speed' is set, this is indicated with the  symbol to the left next to the time on the display.



3. → To accept the settings, press the [START] key.

Continuous run



NOTICE

Dual centrifugation rotors must not be operated in the continuous run.



During the continuous run, the device runs with the set parameters until the [STOP/OPEN] key is pressed.

During the centrifugation run, the rotor speed or the RCF value, the temperature in the centrifuge chamber and the elapsed time are displayed.

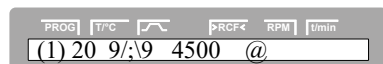

In order to operate the device in a continuous run, proceed as follows:

1. → Set the runtime → 'Runtime (t/hms)' on page 49 (hour, minute and second) to '0'.
2. → To accept the settings, press the [START] key or the [TIME] key, until the centrifugation parameters are displayed.
3. → Save the program → Chapter 7.1.2 'Save programs (STO 1-99)' on page 41.
4. → Press the [START] key to start the run.
 - ➔ The LED in the [START] key flashes until the rotor is read in; then the LED is illuminated. The timer begins at '00:00'.
5. → Press the [STOP/OPEN] key to end the centrifugation run.
 - ➔ The run-down is performed with the selected run-down parameters → Chapter 7.2.2.2 'Braking stage and run-down time' on page 46. The run-down parameter is displayed, e.g. '9'. The right LED in the [STOP/OPEN] key lights up. After the rotor comes to a standstill, the LED in the [START] key goes out and 'OPEN / OEFFNEN' is displayed. The right LED in the [STOP/OPEN] key also goes out, the left LED in the [STOP/OPEN] key starts to flash and flashes until the lid is opened.

7.2.6 Precooling of the rotor



To quickly precool the unloaded rotor and accessories, a centrifugation run at a speed of approx. 20 % of the maximum rotor speed is recommended. Precooling is done automatically with the 'PREC' (PRECOOLING) program.

Precooling is not possible if program linkages are being used.

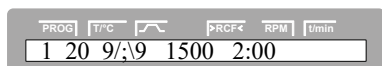

To set the precooling, proceed as follows:

1. ➤ Close the lid.
2. ➤ Press the [Rotor precooling] key.
 - The LED in the [Rotor precooling] key flashes until the rotor is read in; then the LED is illuminated.



You can make changes to the 'PREC' program in the same way as all program changes are made. The 'PREC' program is located after program location 98.

7.3 Machine Menu

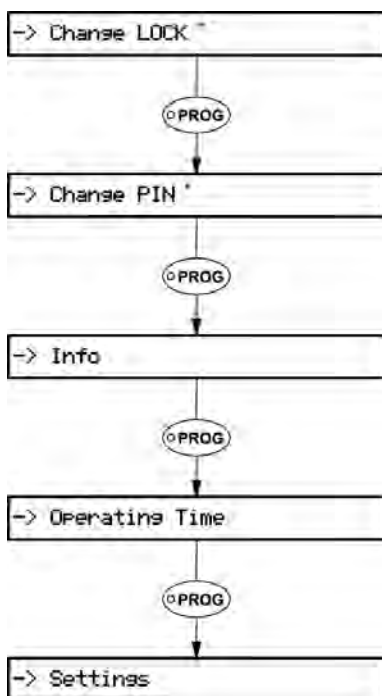
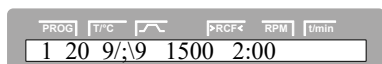

Fig. 29: Menu structure 'Machine Menu'



General device settings can be made in the 'Machine Menu'.

To call up the 'Machine Menu', proceed as follows:



* By entering a PIN, only the program lock (LOCK) can be altered, but none of the other setting options.

1. ➤ Switch the device on ➔ Chapter 5.2 'Setting up, connecting and switching on the device' on page 21.
2. ➤ Keep the [PROG] pressed for 8 seconds.
3. ➤ Release the [PROG] key.
4. ➤ You can scroll forward in the menu with the [PROG] key, and scroll back with the [T/°C] key.
5. ➤ You will get to the corresponding menu with the [START] key.

7.3.1 Change Lock



Please observe the notice → Further information on page 52

When the rotor is at a standstill, the following program locks can be set:

- LOCK 1** **LOCK 1** is displayed in the /\ field. Programs can only be called up but not modified.
- LOCK 2** **LOCK 2** is displayed in the /\ field. No programs can be called up and modified. The device can be controlled via the interface (only for device with interface).
- LOCK 3** No status display. No program lock. Programs can be called up and modified.

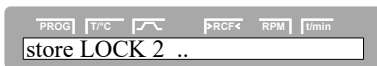

1. → Change to the menu 'Machine Menu → Change LOCK' → Further information on page 51.

2. → Press the [START] key.

→ The lock status is displayed.

If no PIN has been entered, 'LOCK = <3> confirm by START' will be displayed, for example.

If a PIN is entered, 'LOCK = 3' will be displayed, for example.

3. → Set the desired lock status with the [adjusting knob].



If a PIN is entered, 'PIN = ---- confirm by START' will be displayed. In this case, the valid PIN has to first be entered with the [adjusting knob] and then the [START] key pressed before the lock status can be set.

4. → Press the [START] key to save the setting.

5. → [STOP/OPEN] key Press 1x ⇒ Back to the menu 'Machine Menu'.

6. → [STOP/OPEN] key Press 1x ⇒ Back to the main display

7.3.2 Change PIN



Please observe the notice → Further information on page 52



To prevent the program lock from being changed by unauthorized personnel, a PIN can be set.

No PIN is set in the factory.

The PIN can be set as follows:



1. ➤ Change to the menu 'Machine Menu → Change PIN' ➔ Chapter 7.3 'Machine Menu' on page 51.
2. ➤ Press the [START] key.
3. ➤ Set the current PIN with the [adjusting knob].



If the PIN is being set for the first time, then skip this step or set '0000'.

Input assistance:

Keep the respective key pressed while rotating the [adjusting knob].

[Start-up and run-down parameters] key Only the 1000s place of the PIN will be changed.

[RCF] key Only the 100s place of the PIN will be changed.

[RPM] key Only the 10s place of the PIN will be changed.



If an incorrect PIN was set, then 'old PIN = ---- <START>' is displayed. In this case, set the valid PIN with the [adjusting knob] and then press [START].

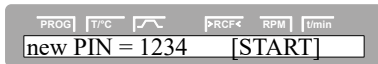

4. ➤ Press the [START] key.
5. ➤ Set the new PIN with the [adjusting knob].



To deactivate the PIN, '0000' must be set.



6. ➤ Press the [START] key to save the setting.
7. ➤ [STOP/OPEN] key Press 1x ➔ Back to the menu 'Machine Menu'.
8. ➤ [STOP/OPEN] key Press 1x ➔ Back to the main display

What to do if PIN is lost



If the PIN was lost, a so-called help number can be called up. Using this number, the manufacturer can calculate a PIN to replace the previously valid PIN. In case this is required, please contact your supplier.

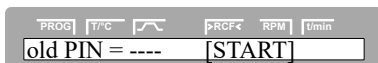

1. ➤ Change to the menu 'Machine Menu → Change PIN' ➔ Chapter 7.3 'Machine Menu' on page 51.
2. ➤ Press the [START] key.



3. Press the *[PROG]* key.



After calling up the help number, the previous PIN will become invalid.



4. Set 'yes' using the *[adjusting knob]*.



5. Press the *[START]* key.



6. Set 'yes' using the *[adjusting knob]*.



7. Press the *[START]* key.



After calling up the help number, the previous PIN will become invalid.

8. Write down the help number and request the required PIN from the manufacturer.

9. Set a new PIN using the received PIN → *Chapter 7.3.2 'Change PIN' on page 52.*

10. *[STOP/OPEN]* key Press 1x ⇒ Back to the menu 'Change PIN'.

11. *[STOP/OPEN]* key Press 1x ⇒ Back to the menu 'Machine Menu'.

12. *[STOP/OPEN]* key Press 1x ⇒ Back to the main display

7.3.3 Info



Please observe the notice → Further information on page 52

The following system information can be queried:

- Device model
- Mains voltage
- Rotor information
- Program version of the device
- Frequency converter program version

The system information can be queried as follows:

1. Change to the menu 'Machine Menu → Info' → *Further information on page 51.*

2. Press the *[START]* key.
 ➔ The device model is displayed.

3. Press the *[PROG]* key.
 ➔ The mains voltage is displayed.



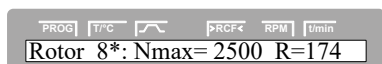

4. Press the *[PROG]* key.
 - The rotor code (rotor), the maximum rotor speed (Nmax) and the preset centrifuging radius (R) of the rotor last detected by the rotor detection function are displayed.



The last detected rotor is marked with an asterisk ().*

The information about the permissible rotors in the device can now be displayed with the [adjusting knob].



5. Press the *[PROG]* key.
 - The program version of the device is displayed.

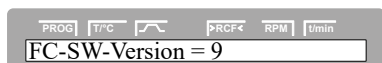

6. Press the *[PROG]* key.
 - The program version of the frequency converter is displayed.

7. *[STOP/OPEN]* key Press 1x ⇒ Back to the menu 'Info'.

8. *[STOP/OPEN]* key Press 1x ⇒ Back to the menu 'Machine Menu'.

9. *[STOP/OPEN]* key Press 1x ⇒ Back to the main display

7.3.4 Operating Time



Please observe the notice ➔ Further information on page 52

Operating Time

The hours of operation are subdivided into internal and external hours of operation.

Internal hours of operation Total time the device was switched on

External hours of operation Total time of the previous centrifugation runs

The query can be performed as follows:



1. Change to the menu 'Machine Menu → Operating Time' ➔ Further information on page 51.



2. Press the *[START]* key.
 - The external hours of operation are displayed.



3. Press the *[PROG]* key.
 - The internal hours of operation are displayed.



4. Press the *[PROG]* key.
 - The number of centrifugation runs is displayed.

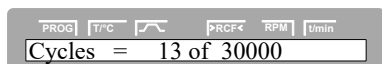

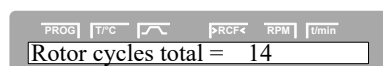

5. Press the *[PROG]* key.
 - The number of running cycles (centrifugation runs) of the used rotor code since the last time the cycle counter was reset to '0' and the permissible number of running cycles are displayed.



6.  Press the *[PROG]* key.
 - ➔ The number of all running cycles (centrifugation runs) of the used rotor code is displayed.



This value is not adjustable.

7.  *[STOP/OPEN]* key Press 1x ⇒ Back to the menu 'Settings'.
8.  *[STOP/OPEN]* key Press 1x ⇒ Back to the menu 'Machine Menu'.
9.  *[STOP/OPEN]* key Press 1x ⇒ Back to the main display

Cycle counter



It is only appropriate to use the cycle counter if the same set of hangers is always worked with.

The cycle counter is activated by setting the maximum permissible cycles.

The device is equipped with a cycle counter, which counts the running cycles (centrifugation runs) of the various rotor codes → *Further information on page 35.*

In the case of swing-out rotors, the cycle counter is used to register the running cycles (centrifugation runs) of the hanger. If a rotor is detected for the first time by the rotor detection function, the centrifugation run is aborted. After pressing any key, 'Enter max cycles = <30000>' will be displayed. The maximum permissible number of running cycles specified on the hanger must be input before the centrifugation run can be restarted → 'Entering maximum permissible number of running cycles / deactivating cycle counter' on page 56.

The cycle counter must be deactivated for rotors and hangers which are not labelled with the maximum permissible number of running cycles.

Every time the lid is opened, the number of running cycles (centrifugation runs) of the used rotor code is briefly displayed, e.g. 'CYCLES 5120 of 30000'. If the input maximum permissible number of running cycles of a hanger is exceeded, '*MAX CYCLES PASSED*' is displayed at the start of a centrifugation run, and the centrifugation run must be restarted.



NOTICE

If '*MAX CYCLES PASSED*' is displayed, the hangers must be immediately replaced with new hangers for safety reasons.

After replacing the hangers, the cycle counter must be reset to '0' again when the rotor is at a standstill. → 'Resetting the cycle counter to 0 / entering maximum permissible number of running cycles' on page 57.

Entering maximum permissible number of running cycles / deactivating cycle counter

After starting the first centrifugation run with a rotor, 'Enter max cycles = <30000>' is displayed.



1. Set the maximum permissible number of running cycles specified on the hanger with the *[adjusting knob]*.



The cycle counter must be deactivated for rotors and hangers which are not labelled with the maximum permissible number of running cycles.

In this case, rotate the *[adjusting knob]* counterclockwise until 'disabled' is displayed ('disabled' = cycle counter deactivated).



2. Press the *[START]* key to save the setting.

Resetting the cycle counter to 0 / entering maximum permissible number of running cycles

The cycle counter can be reset to '0' as follows, or the maximum permissible number of running cycles can be entered.



1. Change to the menu 'Machine Menu → Operating Time' → Further information on page 51.

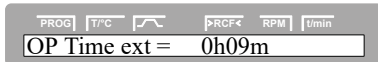

2. Press the *[START]* key.

➡ The external hours of operation are displayed.

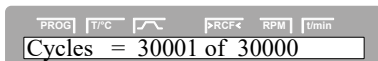

3. Press the *[PROG]* key until the 'Cycles = ' parameter is displayed.



4. Press the *[RCF]* key.

5. With the *[adjusting knob]*, set the value '0' to set the number of running cycles to '0'.



If the running cycles are not reset to '0', 'Max cycles <= actual cycles' is displayed after pressing the *[START]* key, and the setting will not be saved.

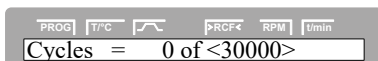

6. Press the *[RCF]* key.

7. Set the maximum permissible number of running cycles specified on the hanger with the *[adjusting knob]*.



By turning the rotary knob, the value for the maximum number of running cycles can be adjusted in **steps of 1000**.

To set other values: Press the *[TIME]* key and turn the *[rotary knob]* simultaneously. The value of the maximum permissible number of running cycles is adjusted in **steps of 1**.



8. Press the *[START]* key to save the setting.

9. *[STOP/OPEN]* key Press 1x → Back to the menu 'Operating Time'.

10. *[STOP/OPEN]* key Press 1x → Back to the menu 'Machine Menu'.

11. *[STOP/OPEN]* key Press 1x → Back to the main display

7.3.5 Settings

7.3.5.1 Sound/Bell



Please observe the notice → Further information on page 52



The acoustic signal sounds at a 2-second interval after a malfunction occurs and at a 30-second interval after the end of the centrifugation run and rotor standstill.

The acoustic signal is ended by opening the lid or pressing any key.



The acoustic signal can be activated or deactivated as follows:

1. → Change to the menu 'Machine Menu → Settings' → Chapter 7.3 'Machine Menu' on page 51.
2. → Press the [PROG] key until the 'Sound/Bell' parameter is displayed.
3. → Set 'on' or 'off' using the [adjusting knob].

'on'	Signal after ending the centrifugation run activated.
'off'	Signal after ending the centrifugation run deactivated.
4. → Press the [START] key to save the setting.
5. → [STOP/OPEN] key Press 1x ⇒ Back to the menu 'Machine Menu'.
6. → [STOP/OPEN] key Press 1x ⇒ Back to the main display

7.3.5.2 Sound/Bell error



Please observe the notice → Further information on page 52



The acoustic signal sounds at a 2-second interval after a malfunction occurs and at a 30-second interval after the end of the centrifugation run and rotor standstill.

The acoustic signal is ended by opening the lid or pressing any key.

The acoustic signal can be activated or deactivated as follows:

1. → Change to the menu 'Machine Menu → Settings' → Chapter 7.3 'Machine Menu' on page 51.
2. → Press the [PROG] key until the 'SOUND/BELL error' parameter is displayed.





3. ➤ Set 'on' or 'off' using the [adjusting knob].

'on'	Signal after malfunction occurs activated.
'off'	Signal after malfunction occurs deactivated.
4. ➤ Press the [START] key to save the setting.
5. ➤ [STOP/OPEN] key Press 1x ⇒ Back to the menu 'Machine Menu'.
6. ➤ [STOP/OPEN] key Press 1x ⇒ Back to the main display

7.3.5.3 Start program

Start program

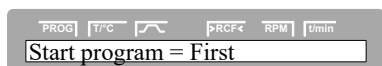
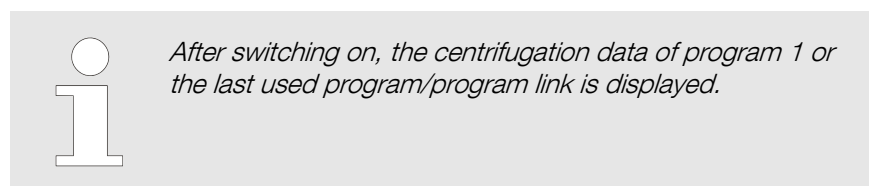

To set what centrifugation data is to be displayed at switch-on, proceed as follows:

1. ➤ Change to the menu 'Machine Menu → Settings' ⇒ Chapter 7.3 'Machine Menu' on page 51.
2. ➤ Press the [PROG] key until the 'Start program' parameter is displayed.
3. ➤ Set 'First' or 'Last' using the [adjusting knob].

'First'	Program at storage space 1 / program link at storage space A.
'Last'	Last used program/program link.
4. ➤ Press the [START] key to save the setting.
5. ➤ [STOP/OPEN] key Press 1x ⇒ Back to the menu 'Machine Menu'.
6. ➤ [STOP/OPEN] key Press 1x ⇒ Back to the main display

7.3.5.4 Temp Unit

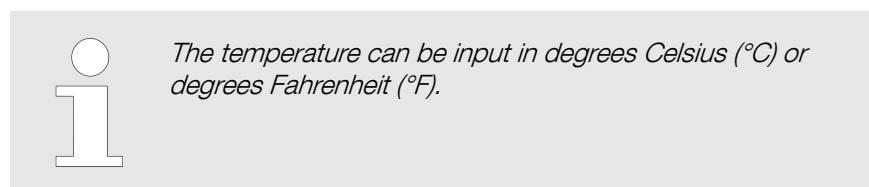
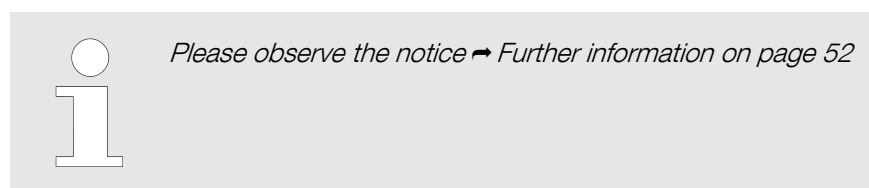

Set the unit of temperature as follows:



1. ➤ Change to the menu 'Machine Menu → Settings' ⇒ Further information on page 51.
2. ➤ Press the [PROG] key until the 'Temp Unit' parameter is displayed.
3. ➤ Set 'Celsius' or 'Fahrenheit' using the [adjusting knob].
4. ➤ Press the [START] key to save the setting.
5. ➤ [STOP/OPEN] key Press 1x ⇒ Back to the menu 'Machine Menu'.
6. ➤ [STOP/OPEN] key Press 1x ⇒ Back to the main display

7.3.5.5 Ramp Unit



Please observe the notice → Further information on page 52



Activate/deactivate the start-up and run-down times as follows:

1. → Change to the menu 'Machine Menu → Settings' → Chapter 7.3 'Machine Menu' on page 51.
2. → Press the [PROG] key until the 'Ramp Unit' parameter is displayed.
3. → Set 'Steps' or 'Steps / Time' using the [adjusting knob].

'Steps'	Start-up and run-down times deactivated.
'Steps / Time'	Start-up and run-down times activated.
4. → Press the [START] key to save the setting.
5. → [STOP/OPEN] key Press 1x → Back to the menu 'Machine Menu'.
6. → [STOP/OPEN] key Press 1x → Back to the main display

7.3.5.6 RCF Integral



Please observe the notice → Further information on page 52

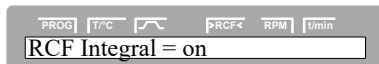

Activate/deactivate the display of the integral RCF as follows:

1. → Change to the menu 'Machine Menu → Settings' → Chapter 7.3 'Machine Menu' on page 51.
2. → Press the [PROG] key until the 'RCF Integral' parameter is displayed.
3. → Set 'on' or 'off' using the [adjusting knob].

'on'	Integral RCF activated.
'off'	Integral RCF deactivated.
4. → Press the [START] key to save the setting.
5. → [STOP/OPEN] key Press 1x → Back to the menu 'Machine Menu'.
6. → [STOP/OPEN] key Press 1x → Back to the main display

7.3.5.7 B-Ramp



No B-brake stages can be set for this device. It is not possible to activate the B braking levels in the 'Settings' menu (parameter 'B-Ramp = off'). B-brake stages are similar to an exponential braking curve.

7.3.5.8 Multi programs



Please observe the notice → Further information on page 52

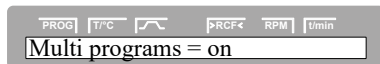

The program link can be activated or deactivated as follows:

1. → Change to the menu 'Machine Menu → Settings' → Chapter 7.3 'Machine Menu' on page 51.
2. → Press the [PROG] key until the 'Multi programs' parameter is displayed.
3. → Set 'off' or 'on' using the [adjusting knob].
 'off' Program link is deactivated.
 'on' Program link is activated.
4. → Press the [START] key to save the setting.
5. → [STOP/OPEN] key Press 1x → Back to the menu 'Machine Menu'.
6. → [STOP/OPEN] key Press 1x → Back to the main display

7.3.5.9 PC Address



The 'PC Address' is the address of the device (serial interface).

The address is set to J = 29th address ex works.



To set the PC address, proceed as follows:

1. → Change to the menu 'Machine Menu → Settings' → Chapter 7.3 'Machine Menu' on page 51.
2. → Press the [PROG] key until the 'PC Address' parameter is displayed.
3. → Use the [adjusting knob] to set the desired value.
4. → Press the [START] key to save the setting.
5. → [STOP/OPEN] key Press 1x → Back to the menu 'Machine Menu'.
6. → [STOP/OPEN] key Press 1x → Back to the main display

7.3.5.10 Cool acc time



If necessary, it can be set that cooling should occur with a time delay after the start of the centrifugation run. The delay time can be set from 15 to 900 seconds in 1-second increments. If no time delay is desired, '0' must be set. No delay time is set ex works.

The delay time can be set as follows:

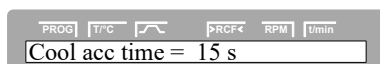

1. → Change to the menu 'Machine Menu → Settings' → Further information on page 51.
2. → Press the [PROG] key until the 'Cool acc time' parameter is displayed.

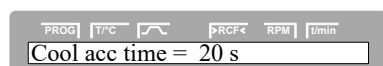

3. Use the *[adjusting knob]* to set the desired value.



'0' = no delay time



4. Press the *[START]* key to save the setting.
5. *[STOP/OPEN]* key Press 1x ⇒ Back to the menu 'Machine Menu'.
6. *[STOP/OPEN]* key Press 1x ⇒ Back to the main display

7.3.5.11 Cool dec speed



If required, it can be set that the cooling is no longer activated at the end of the centrifugation run during the run-down, after reaching a set speed. This way, the stirring up of sediments in the sample can be prevented. This speed can be set from '0' RPM to the maximum rotor speed (N_{max}) in increments of 10.

The speed can be set as follows:



1. Change to the menu 'Machine Menu → Settings' ⇒ Further information on page 51.

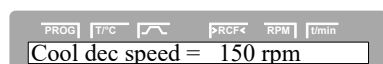

2. Press the *[PROG]* key until the 'Cool dec speed' parameter is displayed.

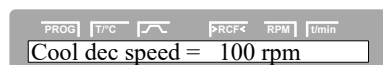

3. Use the *[adjusting knob]* to set the desired value.



4. Press the *[START]* key to save the setting.
5. *[STOP/OPEN]* key Press 1x ⇒ Back to the menu 'Machine Menu'.
6. *[STOP/OPEN]* key Press 1x ⇒ Back to the main display

7.3.5.12 Dual time mode



Please observe the notice ⇒ Further information on page 52



If the 'Dual time mode' function is activated, the beginning of the runtime timer can be defined ⇒ 'Start of runtime timer' on page 49.

The 'Dual time mode' function can be activated or deactivated as follows:



1. Change to the menu 'Machine Menu → Settings' ⇒ Further information on page 51.



2. Press the *[PROG]* key until the 'Dual time mode' parameter is displayed.



3. ➤ Set 'enabled' or 'disabled' using the [adjusting knob].
 'enabled' The function is activated.
 'disabled' The function is deactivated.
4. ➤ Press the [START] key to save the setting.
5. ➤ [STOP/OPEN] key Press 1x ⇒ Back to the menu 'Machine Menu'.
6. ➤ [STOP/OPEN] key Press 1x ⇒ Back to the main display

8 Cleaning, disinfection and maintenance



DANGER

Danger due to insufficient cleaning!

In the case of insufficient cleaning or non-observance of the cleaning regulations, there is a risk of contamination for the user.

- Observe the specified cleaning regulations.
- Observe the laboratory rules (TRBAs, IfSG, hygiene plan, etc.) for handling biological agents.
- Wear personal protective equipment when cleaning the device (gloves, protective clothing, etc.).

Observe the following during cleaning and disinfection:

- The device and the rotor may **not** be cleaned in dishwashers.
- The device and the rotor may **not** be cleaned under running water, in water baths or with compressed air.
- The device and the rotor may **not** be sterilized in autoclaves, since this can destroy the electronic components.
- Only manual cleaning may be performed.
- To avoid signs of corrosion due to cleaning agents and disinfectants, it is imperative that the special instructions for use from the manufacturer of the cleaning agent and disinfectant be observed.



DANGER

Danger due to insufficient maintenance or maintenance not performed in a timely manner!

There is a risk of collision inside the device due to insufficient maintenance or maintenance not performed in a timely manner.

- Have maintenance done at the specified intervals.
- Check the rotor for a firm fit before using the device. Correctly tighten the fastening screw. If the rotor has play, it must be replaced.
- Check the device for visible damage or deficiencies before use. If you discover deficiencies or damage, put the device out of operation and immediately inform an authorized service technician.

8.1 Cleaning

Cleaning

Personnel:

- Authorized skilled personnel with special instruction



NOTICE

To clean the device, use a mixture of anionic and non-ionic surfactants in an aqueous, multivalent alcohol base, which generate a nearly neutral (pH 7 +/-) concentrate. Do not use **any** cleaning agents for cleaning, such as caustic alkalis, peroxides, chlorine compounds, acids or bases.

When using the cleaning agent, observe the safety data sheet from the cleaning agent manufacturer.

- Clean the housing of the device, the centrifuge chamber and the rotor regularly (at least 1x per week and as needed) with the recommended cleaning agent and a damp cloth. This is for hygienic purposes and prevents corrosion due to adhering contaminants.
- After using cleaning agents, remove any cleaning agent residue by wiping with a damp cloth.
- After cleaning, all surfaces must be dried.
- Lightly rub a rubber care product into the rubber seal of the centrifuge chamber after every cleaning.

In order to be able to clean the centrifuge chamber of the device, the rotor can be removed from the device in a few steps → *Chapter 6.5 'Removing and installing the rotor' on page 28.*

1. → Clean the centrifuge chamber of the device.

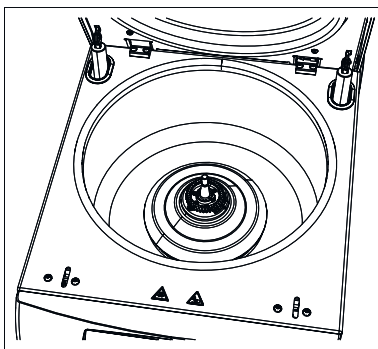

Fig. 30: Centrifuging chamber

1 Centrifuging chamber

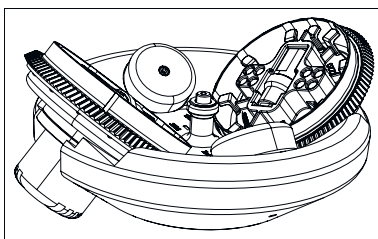

Fig. 31: Rotor

2. → Clean the removed rotor of the device.
3. → If disinfection is not necessary, remount the rotor → *Chapter 6.5 'Removing and installing the rotor' on page 28.* Otherwise, continue with disinfection → *Chapter 8.2 'Disinfection' on page 64.*

8.2 Disinfection

Disinfection

Personnel:

- Authorized skilled personnel with special instruction



NOTICE

To disinfect the centrifuge, use a suitable aldehyde-free disinfectant with an ethanol base (at least 45%) with the following efficacy spectrum:

- bactericidal (incl. MRSA)
- tuberculocidal
- yeasticidal (*C. albicans*)
- virus-inactivating (HBV, HIV, HCV, Vaccinia, BVDV, influenza/Noro viruses)

When using the disinfectant, observe the safety data sheet from the disinfectant manufacturer.

In order to be able to disinfect the centrifuge chamber of the device, the rotor can be removed from the device in a few steps. → Chapter 6.5 'Removing and installing the rotor' on page 28.

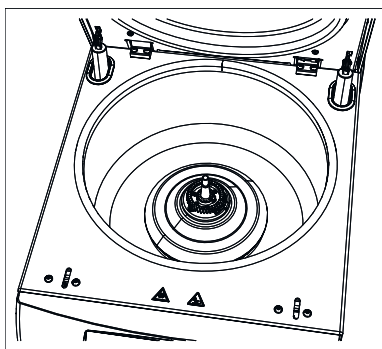

Fig. 32: Centrifuging chamber

1 Centrifuging chamber

1. →



Ingredients of suitable disinfectants:

Ethanol, n-propanol, ethyl hexanol, anionic tensides, corrosion inhibitors.

Do not use spray disinfectants.

Only use wipe disinfectants and thoroughly dry the disinfected areas afterwards.

Disinfect the centrifuge chamber of the device.

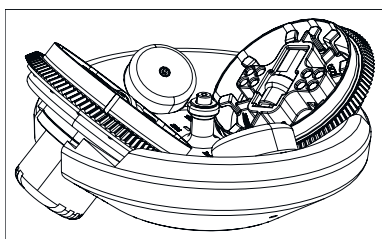

Fig. 33: Rotor

2. → Disinfect the removed rotor.

3. → Remount the rotor after disinfection → Chapter 6.5 'Removing and installing the rotor' on page 28.

8.3 Maintenance

Maintenance

In order to ensure the longevity and error-free running of the device, the device must be maintained at regular intervals by the manufacturer or personnel authorized by the manufacturer.

The manufacturer offers maintenance contracts for this purpose. The operating company and the user are obligated to make sure that the maintenance is carried out by an authorized service technician.

Interval	Maintenance work	Personnel
Before every use	Check the device and accessories to make sure there is no corrosion (rust). Immediately notify a service technician and have the components/assemblies replaced when you find signs of corrosion.	Authorized skilled personnel with special instruction

Interval	Maintenance work	Personnel
Before every use	Check the lifting lugs of the rotor. The lifting lugs of the rotor carry the hangers. These must hang freely during the centrifugation process. For this reason, the lifting lugs must always be lightly greased. Only use the grease provided and approved by the manufacturer.	Authorized skilled personnel with special instruction
Annual maintenance	Check by a service technician from the manufacturer.	Service technician
	Check by a service technician from the manufacturer.	Service technician



In the case of swing-out rotors, the lifting lugs must be greased regularly (Hettich lubricating grease no. 4051), to ensure the hangers swing out evenly.

To grease the lifting lugs, proceed as follows:

1. ➤ Check whether the lifting lugs have an adequate film of grease.
2. ➤ Apply a thin film of grease to the lifting lugs.

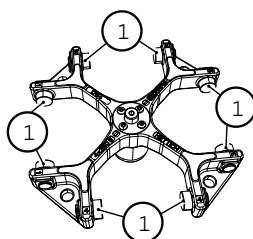

Fig. 34: Greasing the lifting lugs

1 Lifting lugs

9 Troubleshooting



If the error can't be remedied using the troubleshooting table, notify Customer Service. Please specify the type of device and the serial number. Both numbers can be found on the name plate of the device.

Fault description	Cause	Remedy
No display	Device switch switched off.	Switch on the device switch.
	No supply voltage.	Check the supply voltage.
	Overcurrent protection fuse has tripped.	Check the overcurrent protection fuse.
	Circuit breaker tripped.	Reactivate the circuit breaker.
TACHO - ERROR 1, 2, 96	Tachometer, motor or electronics defective.	<ul style="list-style-type: none"> ■ Open the lid. ■ Switch off the device switch (switch setting "0"). ■ Wait for at least 10 seconds. ■ Vigorously turn the rotor by hand.

Fault description	Cause	Remedy
TACHO - ERROR 1, 2, 96	Tachometer, motor or electronics defective.	<ul style="list-style-type: none"> ■ Switch on the device switch again (switch setting "1"). The rotor must turn during switch-on. ■ If the error persists, contact a service technician.
IMBALANCE	The rotor is unevenly loaded.	Check the rotor load. Make sure that the rotor is evenly loaded. ➔ <i>Chapter 6.6 'Loading the rotor' on page 31</i>
CONTROL - ERROR 4.1 – 4.5, 6	Lid lock error	Perform a MAINS-RESET ➔ <i>Chapter 9.1 'Performing a mains reset' on page 69</i> . If the error persists after a mains reset, contact a service technician.
N > MAX 5.0, 5.1	Overspeed	Perform a MAINS-RESET ➔ <i>Chapter 9.1 'Performing a mains reset' on page 69</i> . If the error persists after a mains reset, contact a service technician.
N < MIN 13	Underspeed	Perform a MAINS-RESET ➔ <i>Chapter 9.1 'Performing a mains reset' on page 69</i> . If the error persists after a mains reset, contact a service technician.
ROTORCODE 10.1–10.3	Rotor code error.	Perform a MAINS-RESET ➔ <i>Chapter 9.1 'Performing a mains reset' on page 69</i> . If the error persists after a mains reset, contact a service technician.
VERSION-ERROR 12	No agreement of electronic components, error, electronics defective.	Perform a MAINS-RESET ➔ <i>Chapter 9.1 'Performing a mains reset' on page 69</i> . If the error persists after a mains reset, contact a service technician.
CONTROL-ERROR 22, 25.1–25.4; SER I/O - ERROR 31, 34, 36; ° C * - ERROR 51, 53 – 55, 97, 98; FC INIT ERROR; FC VERSION ERROR; FATAL EEPROM ERROR 1-5	Error, defective electronics.	Perform a MAINS-RESET ➔ <i>Chapter 9.1 'Performing a mains reset' on page 69</i> . If the error persists after a mains reset, contact a service technician.
° C * - ERROR 52.0, 52.1	Overtemperature in the centrifuge chamber. Overtemperature switch defective. Temperature sensor defective.	Perform a MAINS-RESET ➔ <i>Chapter 9.1 'Performing a mains reset' on page 69</i> . If the error persists after a mains reset, contact a service technician.

Fault description	Cause	Remedy
FU / CCI - ERROR 60, 61.2-61.20, 61.128 - 61.131, 62; SENSOR-ERROR 90	Error, defective electronics, motor.	Perform a MAINS-RESET → <i>Chapter 9.1 'Performing a mains reset' on page 69</i> . If the error persists after a mains reset, contact a service technician.
SENSOR-ERROR 91 - 93	Error, defective unbalance sensor.	Perform a MAINS-RESET → <i>Chapter 9.1 'Performing a mains reset' on page 69</i> . If the error persists after a mains reset, contact a service technician.
NO ROTOR OR ROTORCODE ERROR	No rotor installed.	Install rotor → <i>Chapter 6.5 'Removing and installing the rotor' on page 28</i> .
	Tachometer defective.	Perform a MAINS-RESET → <i>Chapter 9.1 'Performing a mains reset' on page 69</i> . If the error persists after a mains reset, contact a service technician.
FU / CCI - ERROR 61.1	Mains voltage too low. Error, defective electronics, motor.	Check the mains voltage. Perform a MAINS-RESET → <i>Chapter 9.1 'Performing a mains reset' on page 69</i> . If the error persists after a mains reset, contact a service technician.
MAINS INTERRUPT	Mains interruption during the centrifugation run. (The centrifugation run was not finished.)	<ul style="list-style-type: none"> ■ Open the lid → <i>Chapter 6.2 'Opening the lid' on page 27</i>. ■ Press the <i>[START]</i> key. ■ Repeat the centrifugation run, if necessary.
WRONG ROTOR !!!	Rotor is not approved for the device.	Install approved rotor → <i>Chapter 6.5 'Removing and installing the rotor' on page 28</i> .
N > ROTOR MAX	Speed in the activated program higher than the maximum rotor speed.	Check the speed and correct.
	The rotor was changed. The installed rotor has a higher maximum speed than the previously used rotor, and it has not yet been detected by the rotor detection function.	Set a speed (up to the maximum speed of the previously used rotor). Press the <i>[START]</i> key to detect the rotor.
N > ROTOR MAX in Prog	There is a program in the displayed program location whose speed is higher than the maximum speed of the rotor.	Check the speed and correct.

Fault description	Cause	Remedy
N > ROTOR MAX in Prog	The rotor was changed. The installed rotor has a higher maximum speed than the previously used rotor, and it has not yet been detected by the rotor detection function.	Set a speed (up to the maximum speed of the previously used rotor). Press the <i>[START]</i> key to detect the rotor.
Runtime 00:00 in Prog	There is a continuous operation program at the displayed program location.	Replace the continuous operation program in the program link with a program with a time preselection.
Empty Program	There is no program linkage saved on the displayed program location.	Call up a program linkage.
Ramp Unit Time in Prog	A program with start-up and/or run-down time is located at the displayed program place.	Replace the program in the program link with a program with start-up and braking stage.
Acc time > Run time	The set start-up time is longer than the run time.	Set a start-up time which is shorter than the run time.

9.1 Performing a mains reset

1. ➤ Switch off the mains switch (switch setting '0').
2. ➤ Wait for at least 10 seconds and then switch the mains switch back on (switch setting 'I').

10 Technical data

Model	ZENTRIMIX 380 R	
Manufacturer	Andreas Hettich GmbH D-78532 Tuttlingen	
Type	3200	3200-01
Mains voltage (± 10%)	200-240 V 1~	110 – 127 V 1~
Mains frequency	50 – 60 Hz	60 Hz
Connected load	1400 VA	1600 VA
Current consumption	6.6 A	15.0 A
Cooling medium	R452A	
Max. capacity	4 x 350 g	
Allowed density	1.2 kg/dm ³ for classical centrifugation	
Speed (RPM)	5000	
Acceleration (RCF)	4863	
Kinetic energy	12260 Nm	

Mandatory testing (DGUV Regeln 100-500)	yes
Device protection class	I
Noise level (rotor-dependent)	≤ 64 dB(A)

Ambient conditions (EN / IEC 61010-1)	
Set-up site	Indoors only
Height	Up to 2000 m above sea level
Ambient temperature	5°C to 35°C
Humidity	Maximum relative humidity 80% for temperatures up to 31°C, linearly decreasing to 50% relative humidity at 40°C.
Overvoltage category (IEC 60364-4-443)	II
Degree of contamination	2
Not suitable for use in explosion-endangered areas	

EMC		
Emitted interference, immunity to interference	EN / IEC 61326-1, Class B	FCC Class B

Dimensions		
Width	472 mm	472 mm
depth	759 mm	769 mm
Height	418 mm	418 mm
Weight	approx. 81,5 kg	approx. 89 kg

10.1 Type plate

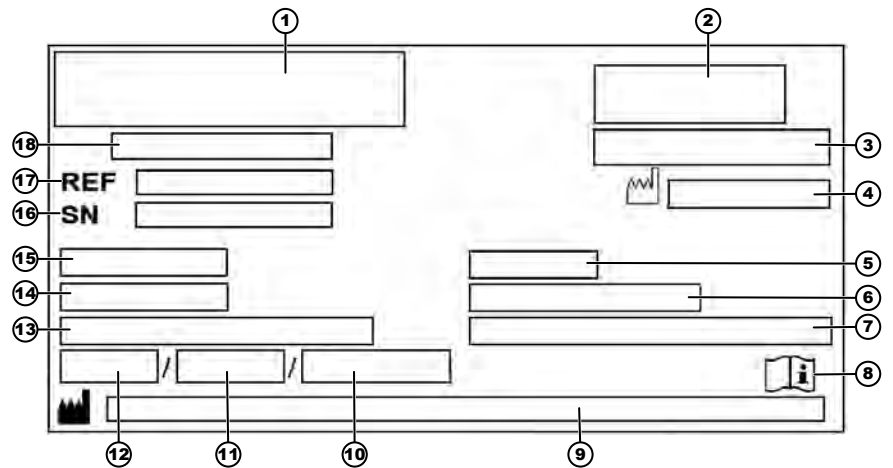

Fig. 35: Type plate

- 1 Manufacturer logo
- 2 EAC mark, CE mark
- 3 Country of manufacture
- 4 Year of manufacture
- 5 Mains supply frequency
- 6 Kinetic energy
- 7 Maximum permissible density of centrifuged substances
- 8 Symbol: Observe the operating instructions.
- 9 Manufacturer address
- 10 Coolant circuit pressure
- 11 Coolant filling volume
- 12 Coolant type
- 13 Maximum rotor speed
- 14 Current consumption
- 15 Connection value, supply voltage
- 16 Serial number
- 17 Type number
- 18 Product designation

10.2 Dimensions

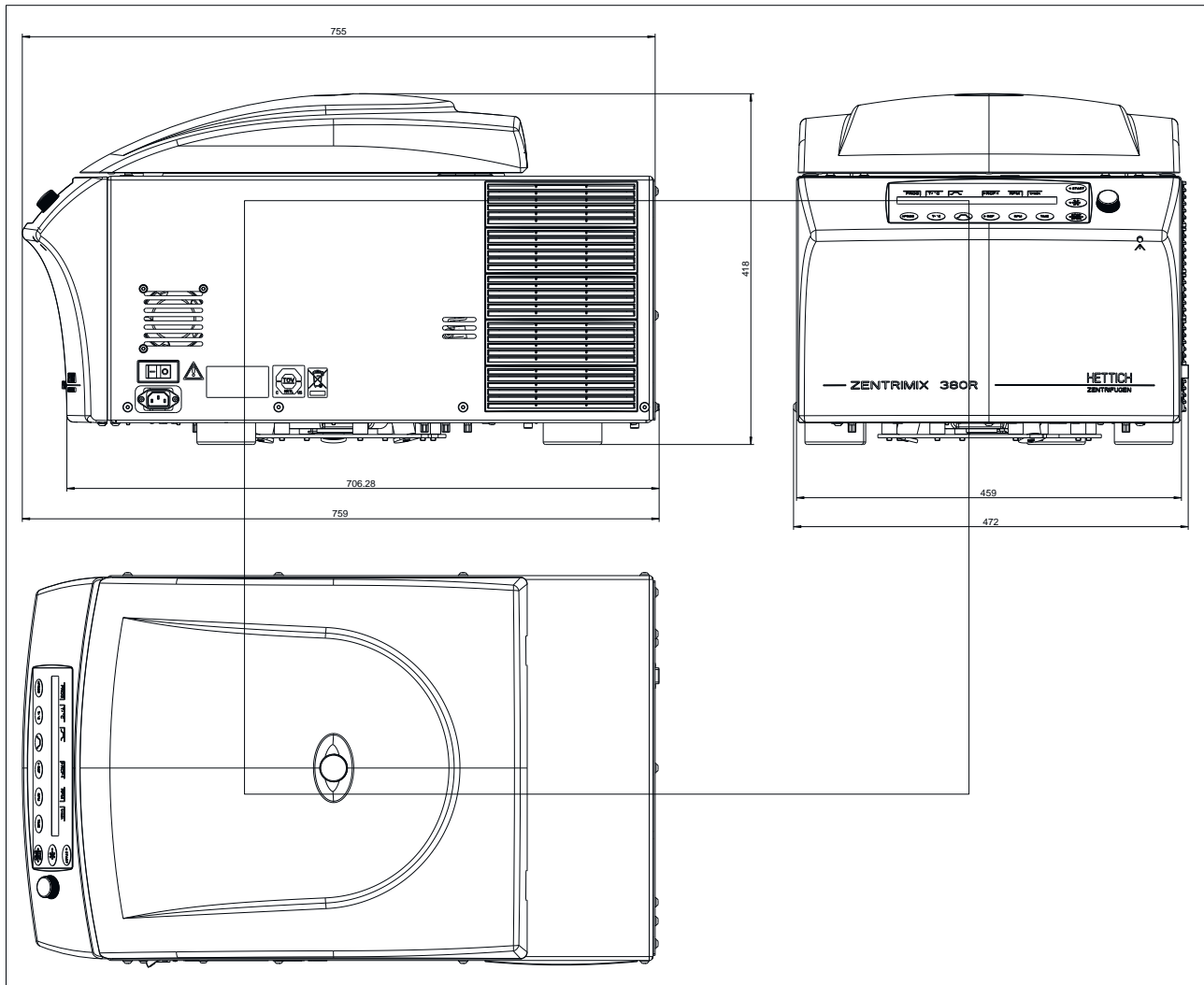

Fig. 36: Dimensions, type 3200

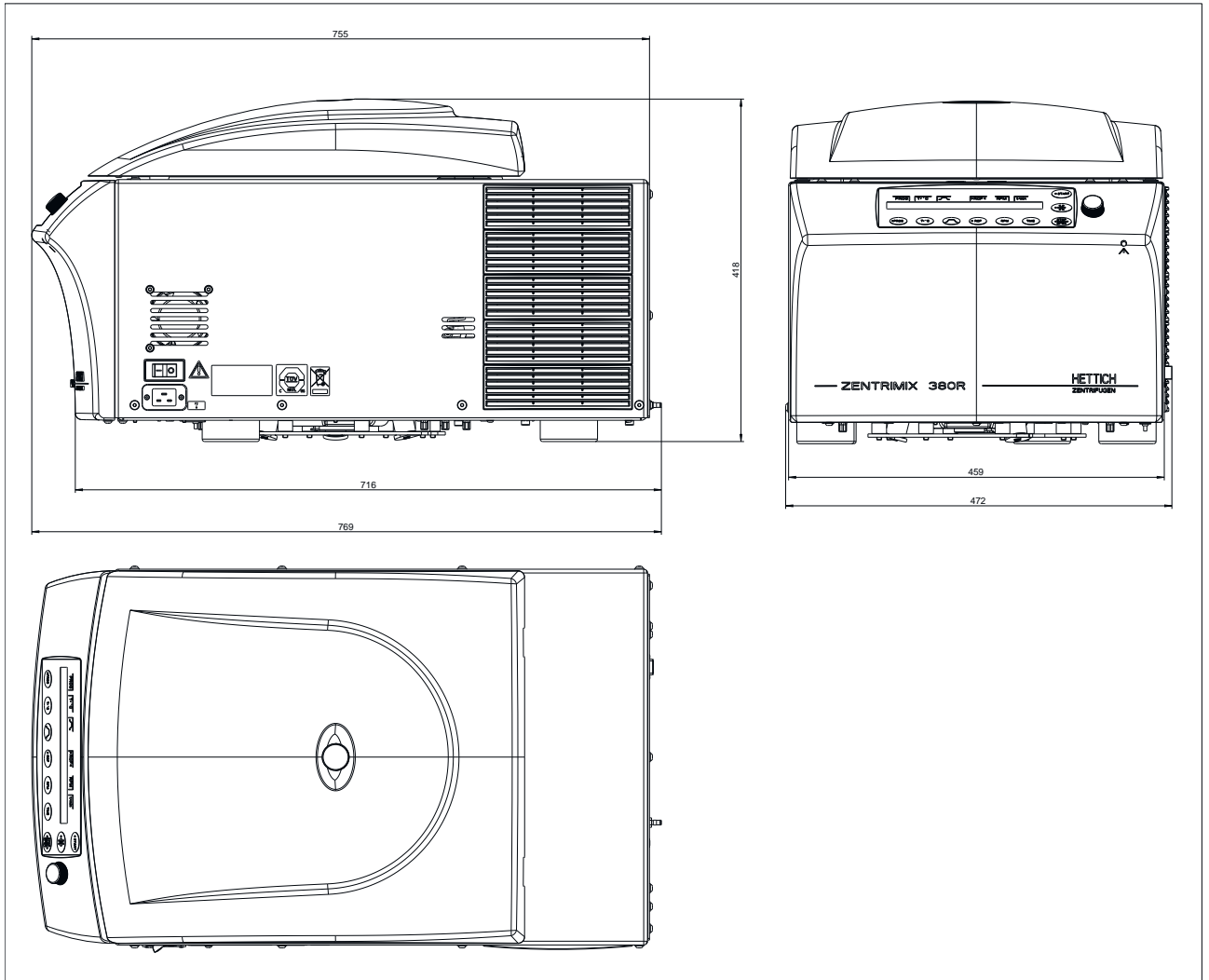

Fig. 37: Dimensions, type 3200-01

11 Disposal

Before disposal, the device must be decontaminated and cleaned to protect people, the environment and property.

Before disposing of the device, the respective legal regulations must be observed.

According to the directive 2012/19/EU, devices may no longer be disposed of in the household waste.



The symbol with the crossed-out trash can indicates that the device must not be disposed of in the household waste.

The disposal regulations of the individual EU countries might vary. In case this is required, please contact your supplier.

12 Glossary

Dual centrifugation

In dual centrifugation, one or more sample containers is centrifuged, each of which rotates additionally about another axis. This special kind of centrifugation leads to a fundamentally different result than classical centrifugation.

While classical centrifugation is a separation method, dual centrifugation is a method for mixing, homogenizing or dispersion.

To differentiate between dual and classical centrifugation, the dual devices are also referred to as "centrifugal mixers", "planetary mixers", etc.

ZentriMixing

Performing dual centrifugation.

13 Index

A

Acoustic signal.	58
Activating or deactivating program linkage.	61
Activating or deactivating start-up and run-down times.	60
Activating or deactivating the display of the integral RCF.	60
Adjusting knob.	24
Automatic buffer.	40
Automatic circuit breaker.	17

B

B-Ramp.	60
Braking stage and run-down time.	46
Braking switch-off speed.	46

C

Calling up program linkage.	42
Calling up programs.	41
Centrifugation data displayed after switching on.	59
Centrifugation parameters.	44
Centrifuging radius (RAD).	47
Change Lock.	52
Change PIN.	52
Changing program links.	43
Changing settings during the centrifugation run.	41
Cleaning.	63
Commissioning.	19
Connection.	22
Connections.	16
Continuous run.	50
Cool acc time.	61
Cool dec speed.	62
Cooling.	39
Cycle counter.	56

D

Deactivating the cycle counter.	56
Device assemblies.	16
Device model.	54
Device switch.	22
Dimensions.	72
Disinfection.	64
Disposal.	73
Dual time mode.	62

E

EDIT.	43
Emergency unlocking.	38
Entering the maximum permissible number of running cycles.	56, 57

F

Foreseeable misuse.	10
Frequency converter program version.	54

G

Get HELP # no.	53
Greasing the lifting lugs.	66

I

Improper use.	10
Info.	54
Inputting or changing programs.	41
Install rotor.	29
Intended use.	9

K

Key

PROG.	26
RCF.	25
Rotor precooling.	27
RPM.	25
START.	27
Start-up and run-down parameters.	26
STOP/OPEN.	27
T/°C.	26
TIME.	25

L

Labels

on the packaging.	8
---------------------------	---

Lid

Close.	27
Opening.	27
Lid with screw closure.	34
Linking a program.	43
Loading the rotor for classical centrifugation.	31

M

Machine Menu.	51
Mains voltage.	54
MAINS-RESET.	69
Maintenance.	63, 65
Multi Programs.	61

N

N Brake.	46
------------------	----

O

Operating elements.	16, 24
Operating Time.	55
Original replacement parts.	10

P

PC Address.	61
Performing a mains reset.	69
Personal protective equipment.	9
Personnel qualification.	9
Personnel qualifications.	9
Preventing cooling from being activated during run-down.	62
Program version of the device.	54
Programs and program links	
Overview.	40
Protective equipment.	9

Q		Speed (RPM).	48
Querying the centrifugation runs.	55	Standby cooling.	39
Querying the cycle counter.	55	Start of centrifugation.	35
Querying the hours of operation.	55	Start of runtime timer.	49
Querying the integral RCF.	47	Start program.	59
Quick-stop function.	28	Start screen.	22
R		Start-up and run-down parameters.	45
RAD.	47	Start-up stage and start-up time.	45
Ramp Unit.	60	Starting centrifugation.	35
RCF.	47	Starting the sequence.	35
RCF Integral.	60	STO.	41, 43
RCL.	41, 42	Storage conditions.	19
Relative centrifugal force (RCF)	47	Storage of bio-safety systems.	35
Removing the rotor.	28	Switching on.	22
Replacement parts.	10	Symbols.	5
Resetting the cycle counter to 0.	57	Symbols on the device.	6
Return shipments.	11	T	
Rotor information.	54	T/°C.	45
RPM.	48	T/°F.	45
Runtime.	49	t/hms.	49
S		Technical data.	69
Safety information		Temp Unit.	59
Damage due to incorrect loading for dual		Time-delayed cooling.	61
centrifugation.	14	Timer starts at Speed.	49
Danger due to electrical energy.	11	Timer starts at Start.	49
Danger due to hazardous substances in the		Transport.	18
sample!.	14	Transport securing device.	21
Danger due to insufficient maintenance or		Troubleshooting.	66
maintenance not performed in a timely manner.	12	Type plate.	71
Danger due to kinetic energy.	12	U	
Danger due to the penetration of water or other		Unpacking the device.	20
liquids.	15	V	
Danger of infections due to improper disposal!.	16	Validating application.	36
Danger posed by selection of unsuitable		W	
parameters for dual centrifugation.	13	Warning of hand injury due to rotor gears.	12
Explosion and fire hazard.	14	Warning symbols.	5
Mechanical emergency release.	16	What to do if PIN is lost.	53
Risk of injury due to parts falling out of the		Write protection for programs.	40
packaging.	13		
Warning - Impermissible ambient temperature.	15		
Warning - Position changed due to vibration.	15		
Warning of hand injury due to device lid falling			
closed unbraked.	13		
Warning of premature program abort!.	12		
Saving a program link.	43		
Scope of delivery.	10		
Setting or changing the PIN.	52		
Setting program locks.	52		
Setting the temperature.	45		
Setting the unit of temperature.	59		
Setting up the centrifuge.	21		
Short-term centrifugation.	36		
Signal after ending the centrifugation run.	58		
Signal after malfunction occurs.	58		
Signal words.	5		
SOUND / BELL.	58		
SOUND / BELL error.	58		

14 Appendix

A Rotors and accessories

Rotor	Hangers	Insert/adaptor	Radius [mm]
3205	-	3211	118
		3221-A	124
		3236	147
3206	-	3211	118
		3218	150
		3221-A	124
		3236	147
3234	1752	1738	174
		1761	125 / 171
		1762-A	167
		1763-A	167
		1764	167
		1765	167
		1766	166
		1767	166
		1768	166
		1769	174
		1771-A	174
		1772-A	174
		1773	168
		1774-A	170
		1775	172
		1777	172
		1778	174
		1779	162
		1781	167
		1782	174
1783-A	167		
1787	167		

Rotor	Hangers	Insert/adaptor	Radius [mm]
		3235	168

Tab. 1: Centrifuging radius

Hanger + lid	1752 + 1751
--------------	-------------

Tab. 2: Bio-safety systems

Rotor	Hanger/insert/adaptor	Lid	Bio-seal
3205	3211	-	no
	3221-A		
	3236		
3206	3211	-	no
	3218		
	3221-A		
	3236		
3234	1752	1751	yes

Tab. 3: Bio-seal

Rotor	Maximum number of running cycles	Period of use [years]
3205 *	2500	-
3206 *	10000	-
3234	-	-

Tab. 4: Maximum load, maximum number of running cycles and period of use

Hanger / insert	Maximum number of running cycles	Period of use [years]
1752	80000	-
3211	10000	1
3218		
3221-A		
3236		

* After reaching the maximum number of running cycles, it is imperative that the rotor undergo a general overhaul.

Rotor	Hanger/insert/adapter	Speed	^/9 (97%) [sec]	^_9 [sec]	Temperature [°C] ¹⁾
3205	3211	2500	22	24	20
	3221-A				
	3236				
3206	3211	1500	22	24	20
	3218				
	3221-A				
	3236				
3234	1752	5000	42	27	0

Tab. 5: Start-up and run-down time, lowest reachable temperature in the centrifuge chamber

¹⁾ Lowest reachable temperature at maximum speed, 1 h running time and 20°C room temperature

Hanger/insert/adapter	Removal aid
3221-A	3223
3236	3210

Tab. 6: Removal aid